

# GUIA DE PRODUTOS

**FGVTN**  
Brasil  
Ferragens para móveis



NOSSAS MARCAS  
DE PRODUTOS

**FGVTN**  
Brasil

**FGV** COMERCIAL

**TN**

# CONHEÇA A LINHA COMPLETA DE CORREDIÇAS **ONE-TOUCH E SLOWMOTION.**

O sistema de fechamento suave **slowmotion** possui mecanismo de **amortecimento integrado**, garantindo um fechamento de gavetas leve e sem ruídos, minimizando o impacto e, com isso, aumentando a vida útil do móvel.

O sistema **One-Touch** proporciona abertura das gavetas com um toque, sem a necessidade de puxadores. Para fechar, basta empurrar a gaveta até o final.



## Sistema **Slowmotion:**

■ Usar o puxador para abrir a gaveta.



■ Abra totalmente a gaveta.



■ Empurre suavemente a gaveta e solte.



■ Fechamento automático suave sem ruído.



## Sistema **One-Touch:**

■ Pressione a frente da gaveta.



■ Abra totalmente a gaveta com a mão.



■ Pressione levemente para fechar.



[fgvtn.com.br](http://fgvtn.com.br)



**FGVTN**  
Brasil  
Ferragens para móveis

## CORREDIÇAS OCULTAS

Corrediça FGVTN Oculta UniHide Slow.....	6
Corrediça FGVTN Oculta UniHide One-Touch.....	6
Gatilho 3D para Corrediça Oculta.....	6
Corrediça FGVTN Oculta One-Touch ET.....	7
Corrediça FGVTN Oculta One-Touch EP.....	7
Corrediça FGVTN Oculta Slowmotion ET.....	7
Corrediça FGVTN Oculta Slowmotion EP.....	7
Corrediça FGVTN Oculta Slowmotion com Pino ET.....	8
Corrediça FGVTN Oculta Slim Slow EP.....	8
Acessório para Corrediça TN Oculta Calço Plástico 6/7 mm.....	8

## CORREDIÇAS TELESCÓPICAS

Corrediça Telescópica FGVTN TT 45 Slowmotion.....	9
Corrediça Telescópica FGVTN TT 44 Slowmotion.....	9
Corrediça Telescópica FGVTN TT 35 Slowmotion.....	9
Corrediça Telescópica FGVTN TT 45 One-Touch.....	10
Corrediça Telescópica FGVTN TT 44 One-Touch.....	10
Corrediça Telescópica FGVTN TT 35 One-Touch.....	10
Corrediça Telescópica FGVTN TT 58 Self-Closing.....	10
Corrediça Telescópica FGVTN TT 50 Self-Closing.....	11
Corrediça Telescópica FGVTN TT 45 Self-Closing.....	11
Corrediça Telescópica FGVTN TT 45 com Engate.....	11
Corrediça Telescópica TT 45 TSI.....	11
Corrediça Telescópica FGVTN TT 45.....	12
Corrediça Telescópica FGVTN H45.....	12
Corrediça Telescópica TN H45.....	12
Corrediça FGVTN Larga ZA.....	13
Corrediça Telescópica FGVTN H35.....	13
Corrediça Telescópica TN Mini H35.....	13
Corrediça Simples de Roldanas TTS 082.....	14
Acessório para Corrediça 082 Calço 082 25/30 mm.....	14
Corrediça Telescópica FGVTN H45 Inox.....	15
Corrediça Telescópica FGVTN H45 Inox Slowmotion.....	15

## DOBADIÇAS

Dobradiça FGVTN Click 3D Slow.....	16
Dobradiça FGVTN Click Slow.....	16
Dobradiça Easy TN Click Slow Inox Calço Duplo.....	17
Nova Dobradiça TN Click Slow.....	17
Dobradiça TN Click Slow Easy.....	18
Dobradiça FGVTN Click 3D Slow Móveis em Ângulo.....	18
Dobradiça FGVTN Click 3D Slow Móveis em Ângulo 165°.....	19
Dobradiça FGVTN Click Slowmotion Móveis em Ângulo.....	19
Dobradiça FGVTN Click Slowmotion 165° Móveis em Ângulo.....	20
Dobradiça FGVTN Click Slow Reta 155° Zero PR.....	20
Dobradiça MS Slow Next FGVTN.....	20
Dobradiça TN MS Slow Easy.....	21
Dobradiça FGVTN MS Slow.....	21
Dobradiça TN Inox Slowmotion.....	21
Dobradiça TN MS Slow Calço Duplo.....	22
Dobradiça Série M Slide-On 110°.....	22
Dobradiça MS Abertura Automática.....	23
Dobradiça MS Sem Mola.....	23
Dobradiça Série M Slide-On Portas de Alumínio.....	24
Dobradiça para Portas Basculantes.....	24
Dobradiça TN Inox.....	24
Dobradiça TN Slide-On Calço Duplo.....	25
Dobradiça QS Mini FGV.....	25
Dobradiça TN Mini HB.....	25
Dobradiças Série M Slide-On Móveis em Ângulo.....	26
Dobradiça Série M Slide-On 175°.....	26
Dobradiça TN 165°.....	27
Dobradiça TN Móveis em Ângulo -45°.....	27
Dobradiça TN Mini 45°.....	27
Dobradiça FGVTN MS Slow Calço Fixo.....	28
Dobradiça TN MS Slow Calço Fixo.....	28

## ACESSÓRIOS PARA MÓVEIS

Prateleira Vidro Sense.....	29
Calceiro Sense.....	29
Cesto Virne Sense.....	30
Sapateira Sense.....	30
Porta-Jóias Sense.....	30
Cesto Metálico Sense.....	31
Organizador em Madeira Sense.....	31
Tábua de Passar TP 450.....	32
Tábua de Passar TP 480.....	32
Tábua de Passar TP 800.....	32
Easy Shelf Prateleira Basculante.....	33
Canto Articulado FGVTN Slow.....	33
Lixeira Automática FGVTN.....	33
Calceiro Deslizante CD 135.....	34
Calceiro Deslizante CD.....	34
Calceiro SPIN.....	35
Cabideiro SPIN.....	35
Kit Escorredor de Louças FGVTN.....	36
Ferragem Deslizante para Mesa de Embutir TT 10 302.....	36
Prato Giratório PG 1012.....	36
Pés de Mesa FGVTN.....	37
Suporte Dobrável Compacto para Tampo.....	37
Suporte Dobrável para Tampo.....	37
Cabideiro Basculante FGVTN Dual Slow.....	38
Cabideiro Basculante TN.....	38
Porta-Panos Deslizante TTS 40 202 e TTS 40 104.....	38
Ferragem Deslizante para Teclado TTS 082 BT.....	39
Ferragem Deslizante para Teclado TTS 40 504.....	39
Ferragem Deslizante para Teclado TTS 40 404.....	39
Ferragem Deslizante para Teclado TTS 40 204.....	40
Base para Teclado TN 27/350.....	40
Rodízio FGVTN.....	40
Rodízio Neoo FGVTN.....	41
Rodízio Gel TN.....	41
Rodízio Gel TN Base Fixa.....	42
Porta-Pratos FGVTN.....	42
Porta-Facas Inox FGVTN.....	42

## SISTEMAS DESLIZANTES

Sistema Deslizante SDS 800 Slow.....	43
Amortecedor para Porta Central.....	43
Sistema Deslizante Coplanar.....	44
Rodízio SD 802.....	44
Rodízio SD 801.....	44
Rodízio SD FGVTN Click Slow Reta 155° Zero PR.....	45
Rodízio SD 631.....	45
Rodízio SD 605.....	45
Rodízio SD 603.....	45
Rodízio SD 524.....	46
Rodízio SD 523.....	46
Rodízio SD 505.....	46
Rodízio SD 401.....	46
Rodízio SD 309.....	47
Rodízio SD 308.....	47
Rodízio SD 307.....	47
Rodízio SD 306.....	47
Rodízio SD 305.....	48
Rodízio SD 304.....	48
Rodízio SD 303.....	48
Rodízio SD 302.....	48
Rodízio SD 301.....	49
Rodízio SD 152.....	49
Rodízio SD 102.....	49
Rodízio SD 101.....	49
Desempenador de Portas Embutido FGVTN.....	50
Desempenador de Portas Sobreposto FGVTN.....	50

Deslizador de Piso DP 01.....	50
Batente de Borracha para Portas.....	50
Guia Superior Articulada para SD.....	51
SoftDoor - Dispositivo Slowmotion para Portas de Correr.....	51

### SISTEMAS DE ABERTURA

Articulador FGVTN Multi.....	52
Articulador FLAP FGVTN 902.....	52
Braço de Abertura Variável BVO.....	52
Pistão a Gás com Amortecedor FGVTN.....	53
Pistão a Gás TN.....	53
Pistão a Gás TN FI.....	54
Pistão a Gás TN Mini FI.....	54
Pistão a Gás TN Mini.....	54
Pulsador Magnético Embutido FGVTN Mini.....	55
Pulsador Magnético FGVTN Embutido e Sobreposto.....	55
Pulsador Magnético TN.....	55
Pulsador Magnético TN Industrial.....	56
Fecho Toque Articulado TN.....	56
Amortecedor TN com Suporte Cruz.....	56
Amortecedor TN com Suporte Linear.....	56

### AEROS

AeroMax Slow.....	57
AeroMax Touch.....	57
AeroFlex.....	58
AeroVert Plus.....	58
AeroSmart.....	59
AeroPlus.....	59

### GAVETAS METÁLICAS

Kit Gaveta Metálica AvantBox® Slowmotion.....	60
Kit Gaveta Metálica AvantBox® One-Touch.....	60
Kit Gaveta Metálica AvantBox® Tubo Lateral e Transversal.....	61
Kit Gaveta Metálica AvantBox® Elevação Lateral em Acrílico.....	61
Kit Gaveta Metálica AvantBox® Elevação Lateral Metálica.....	62
Divisor Central para Gavetas AvantBox®.....	62
Tapete Emborrachado para Gavetas.....	62
Divisores Internos para Gavetas AvantBox®.....	63
Kit Gaveta Metálica AvantBox® Slim Baixa H89.....	63
Acessório para Gaveta Metálica AvantBox® Slim Baixa H89.....	64
Kit Gaveta Metálica AvantBox® Slim Média H121.....	64
Acessório para Gaveta Metálica AvantBox® Slim Média H121.....	64
Kit Gaveta Metálica AvantBox® Slim Alta H185.....	65
Acessório para Gaveta Metálica AvantBox® Slim Alta H185.....	65
Acessório para Elevação Lateral e Transversal.....	65
Porta-Talheres Tetric Universal em Plástico.....	66
Perfil de União.....	66
Divisores Internos em Aço Inox.....	67
Divisor de Talheres FGVTN.....	68

### LINHA OFFICE

Quadro para Pasta Suspensa QPS 800.....	69
Quadro para Pasta Suspensa QPS 1000.....	69

### FECHADURAS PARA MÓVEIS

Fechadura para Gaveta 20x17 mm.....	70
Fechadura para Gaveta 31x17 mm.....	70
Fechadura para Armário Vertical.....	70
Fechadura de Sobrepor para Gaveta 19x21 mm.....	71
Fechadura para Gaveteiro Frontal.....	71
Fechadura para Gaveteiro Frontal 1 Aba.....	71
Fechadura para Porta Vidro.....	71
Fechadura para Portas de Vidro Duplo.....	72
Fechadura para Vitrine 140 mm.....	72
Fechadura para Porta de Correr.....	72
Fechadura para Móveis de Madeira 19x20 mm.....	73
Fechadura para Móveis em Aço com Lingueta.....	73
Fechadura Cilindro de Pressão 22x36 mm.....	73
Fechadura para Gaveta 20x17 mm Lingueta Longa.....	73

Fechadura Cilindro de Pressão para Porta de Correr 8x11 mm.....	74
Batente Metálico para Fechaduras.....	74
Batente Plástico 10x30 mm.....	74
Calço Plástico Ø17x47 mm.....	74
Pino Batente para Barras de Travamento.....	75
Fechadura para Gaveteiro Frontal com Acessórios e Barra.....	75
Fechadura para Gaveteiro Lateral com Acessórios e Barra.....	76
Fechadura Cremona com Lingueta e Acessórios.....	76

### FIX SYSTEM

Dispositivo FBA45 Zamak Niquelado 16/19 mm.....	77
Dispositivo FBA45 Plástico 16/19 mm.....	77
Dispositivo FB Zamak Niquelado 16/19 mm.....	77
Dispositivo FB Plástico 16/19 mm.....	77
Dispositivo FAA45 Zamak Niquelado 16/19 mm.....	78
Dispositivo FAA45 Plástico 16/19 mm.....	78
Dispositivo FA Zamak Niquelado 16/19 mm.....	78
Dispositivo FA Plástico 16/19 mm.....	78
Parafuso FA/FB Aço Zincado 1/4"x11 mm.....	78
Parafuso FA/FB Aço Zincado M6x8 mm.....	78
Parafuso Aço FA/FB com Ponta 1/4"x21,5 mm.....	79
Parafuso FA/FB Aço Zincado 1/4"x7,5 mm.....	79
Haste Dupla FA/FB Aço Zincado 19 mm.....	79
Haste Dupla FA/FB Aço Zincado 16 mm.....	79
Tambor Zamak Zincado 15x12 mm.....	79
Tambor Zamak Zincado 15x13,5 mm.....	79
Parafuso Aço Zincado 6x32 mm.....	80
Parafuso Aço Zincado M6x32 mm.....	80
Haste Dupla/Trava Aço Zincado 67 mm.....	80
Haste Dupla/Trava Aço Zincado 64 mm.....	80
Bucha Americana Zamak Bicromatizado M6x13 mm.....	80
Bucha Plástica Ø1,4"10x11 mm.....	80
Bucha Plástica M6 10x11 mm.....	81
Bucha Plástica Branca Ø10x10 mm.....	81
Suporte Prateleira Pino Duplo Zamak Niquelado.....	81
Suporte Prateleira Fixa Plástico.....	81
Suporte Prateleira Aço Niquelado 7,5x12,5 mm.....	81
Suporte Prateleira Trapézio Plástico Incolor e Aço Niquelado.....	81
Suporte Prateleira Vidro Zamak Niquelado 6 a 10 mm.....	82
Suporte Prateleira Duplo Ø5x16 mm.....	82
Suporte Prateleira 90 Zamak Niquelado 5 mm.....	82
Suporte Prateleira Vidro Zamak Niquelado 3 a 6 mm.....	82
Suporte Prateleira Vidro Paralelo Zamak Niquelado.....	82
Suporte Prateleira Vidro 90 Zamak Niquelado.....	82
Suporte Prateleira Niquelado 17x17 mm 2 Furos.....	83
Suporte Plástico 10x15 mm.....	83
Arremate Plástico 10x9 mm.....	83
Suporte Prateleira 2 Furos Zamak Niquelado ou Branco.....	83
Trapézio Plástico Ø5x10 mm.....	83
Suporte Plástico Ø8xØ6 mm.....	84
Parafuso União Plástico 30-40.....	84
Trava Prateleira Plástico 18 mm.....	84
Trava Prateleira Plástico 16 mm.....	84
Parafuso União Niquelado 30-40.....	84
Parafuso Euro Aço Niquelado 6,3x15 mm.....	84
Parafuso Aço Niquelado 4x15,5 mm.....	85
Parafuso Aço Niquelado sem Ponta para Bucha.....	85
Porca Cilíndrica Zamak Natural 1/4".....	85
Tapa Furo Plástico Ø5 mm.....	85
Tapa Furo Plástico Ø8 mm.....	85
Tapa Furo Plástico Ø10 mm.....	85
Tapa Furo Plástico Ø12 mm.....	86
Porca Garra M8x10 mm.....	86
Porca Garra M6x10 mm.....	86
Suspensor FGVTN HB65.....	86
Suspensor de Armário.....	86
Pé Nivelador.....	87
Pé Nivelador D27,5 M6x25.....	87
Pé Nivelador Inox D38 M8x15.....	87
Pé Nivelador.....	87

## Número de dobradiças **por porta:**

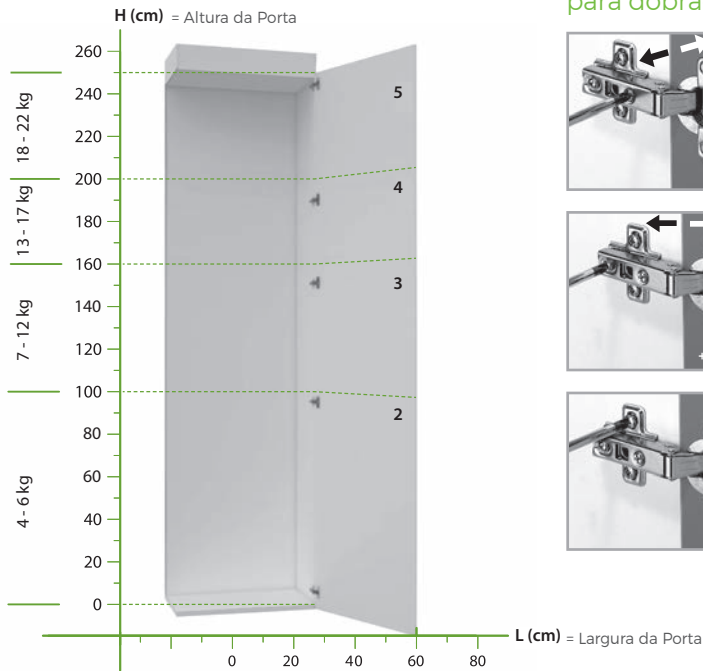

## Sistema de Regulação para dobradiças:

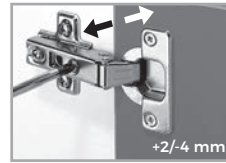

Regulagem da cobertura lateral



Regulagem da folga horizontal



Regulagem do alinhamento vertical

## Conheça o sistema de montagem **Slide-On** para dobradiças:

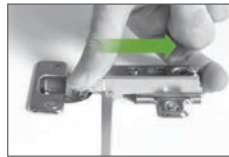
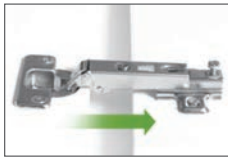

## Conheça o sistema de montagem **M Click** para dobradiças:



### Calços para Dobradiças Slide-On

### Tabelas de Calços para dobradiças:

Código	Descrição	Embalagem
520201M5001R000	Calço Cruz 0 mm Dobradiça MS	500 peças
520201M5021R000	Calço Cruz 2 mm Dobradiça MS	500 peças
520201M5041R000	Calço Cruz 4 mm Dobradiça MS	500 peças
520201M5061R000	Calço Cruz 6 mm Dobradiça MS	500 peças

+ no SITE: Catálogos, manuais de instalação e desenhos técnicos



LANÇAMENTO

Corrediça FGVTN Oculta

UNIHide  
SLOW



+no SITE

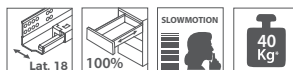

Acabamento: Zincado | Extração Total

Código	Descrição	Emb.
54OC1812300TSX0	300 mm	10 pares
54OC1812350TSX0	350 mm	10 pares
54OC1812400TSX0	400 mm	10 pares
54OC1812450TSX0	450 mm	10 pares
54OC1812500TSX0	500 mm	10 pares
54OC1812550TSX0	550 mm	10 pares

LANÇAMENTO

Corrediça FGVTN Oculta

UNIHide  
ONE-TOUCH



+no SITE

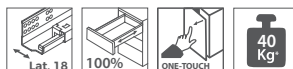

Acabamento: Zincado | Extração Total

Código	Descrição	Emb.
54OC1812300TOT0	300 mm	10 pares
54OC1812350TOT0	350 mm	10 pares
54OC1812400TOT0	400 mm	10 pares
54OC1812450TOT0	450 mm	10 pares
54OC1812500TOT0	500 mm	10 pares
54OC1812550TOT0	550 mm	10 pares

LANÇAMENTO

Gatilho 3D para Corrediça Oculta UNIHide



+no SITE

Código	Descrição	Emb.
54TNOC12GAT3D	Gatilho 3D p/Oculta	50/1 conj.

## Corrediça FGVTN Oculta One-Touch ET



+no SITE



**Acabamento:** Zincado ET (Extração Total)

Código	Descrição	Emb.
54FGOC12300TOTO	300 mm	10 pares
54FGOC12350TOTO	350 mm	10 pares
54FGOC12400TOTO	400 mm	10 pares
54FGOC12450TOTO	450 mm	10 pares
54FGOC12500TOTO	500 mm	10 pares
54FGOC12550TOTO	550 mm	10 pares

## Corrediça FGVTN Oculta One-Touch EP



+no SITE



**Acabamento:** Zincado EP (Extração Parcial)

Código	Descrição	Emb.
54FGOC12300POTO	300 mm	10 pares
54FGOC12350POTO	350 mm	10 pares
54FGOC12400POTO	400 mm	10 pares
54FGOC12450POTO	450 mm	10 pares
54FGOC12500POTO	500 mm	10 pares
54FGOC12550POTO	550 mm	10 pares

## Corrediça FGVTN Oculta Slowmotion ET



+no SITE



**Acabamento:** Zincado ET (Extração Total)

Código	Descrição	Emb.
54FGOC12300TSX0	300 mm	10 pares
54FGOC12350TSX0	350 mm	10 pares
54FGOC12400TSX0	400 mm	10 pares
54FGOC12450TSX0	450 mm	10 pares
54FGOC12500TSX0	500 mm	10 pares
54FGOC12550TSX0	550 mm	10 pares

## Corrediça FGVTN Oculta Slowmotion EP



+no SITE



**Acabamento:** Zincado EP (Extração Parcial)

Código	Descrição	Emb.
54FGOC12300PSX0	300 mm	10 pares
54FGOC12350PSX0	350 mm	10 pares
54FGOC12400PSX0	400 mm	10 pares
54FGOC12450PSX0	450 mm	10 pares
54FGOC12500PSX0	500 mm	10 pares

## Corrediça FGVTN Oculata Slowmotion com Pino ET



+no SITE



**Acabamento:** Zincado ET (Extração Total)

Código	Descrição	Emb.
54FPOC12350TSX0	350 mm	10 pares
54FPOC12400TSX0	400 mm	10 pares
54FPOC12450TSX0	450 mm	10 pares
54FPOC12500TSX0	500 mm	10 pares
54FPOC12550TSX0	550 mm	10 pares

## Corrediça FGVTN Oculata Slim Slow EP



+no SITE



**Acabamento:** Zincado EP (Extração Parcial)

Código	Descrição	Emb.
54FS OC12300PSX0	300 mm	15 pares
54FS OC12350PSX0	350 mm	15 pares
54FS OC12400PSX0	400 mm	15 pares
54FS OC12450PSX0	450 mm	15 pares
54FS OC12500PSX0	500 mm	15 pares

### LANÇAMENTO

## Acessório para Corrediça Oculata Calço Plástico 6/7 mm



+no SITE

PAT.  
REQ.

**Acabamento:** Polipropileno cinza

Código	Descrição	Emb.
0074.000307	6/7 mm	1.000 un.

# SAIBA +

# UNIHide

ONE TOUCH E SLOWMOTION

Projetadas para  
MDF 18 mm

Podem ser instaladas  
com gatilho 3D  
(vendido separadamente)







## Corrediça Telescópica **FGVTN TT 45 Slowmotion**



**Acabamento:** Zinco Acetinado

Código	Descrição	Emb.
0073.045ASX <b>350</b>	350 mm	10 pares
0073.045ASX <b>400</b>	400 mm	10 pares
0073.045ASX <b>450</b>	450 mm	10 pares
0073.045ASX <b>500</b>	500 mm	10 pares
0073.045ASX <b>550</b>	550 mm	10 pares



+no SITE

## Corrediça Telescópica **FGVTN TT 44 Slowmotion**



**Acabamento:** Zinco Acetinado

Código	Descrição	Emb.
0073.044 <b>350</b> SX	350 mm	10 pares
0073.044 <b>400</b> SX	400 mm	10 pares
0073.044 <b>450</b> SX	450 mm	10 pares
0073.044 <b>500</b> SX	500 mm	10 pares
0073.044 <b>550</b> SX	550 mm	10 pares



+no SITE

## Corrediça Telescópica **FGVTN TT 35 Slowmotion**



**Acabamento:** Zinco Acetinado

Código	Descrição	Emb.
0073.035 <b>350</b> SX	350 mm	20 pares
0073.035 <b>400</b> SX	400 mm	20 pares
0073.035 <b>450</b> SX	450 mm	20 pares
0073.035 <b>500</b> SX	500 mm	20 pares
0073.035 <b>550</b> SX	550 mm	20 pares



+no SITE

## Corrediça Telescópica FGVTN TT 45 One-Touch



+no SITE



**Acabamento:** Zinco Acetinado

Código	Descrição	Emb.
0073.045AOT <b>350</b>	350 mm	10 pares
0073.045AOT <b>400</b>	400 mm	10 pares
0073.045AOT <b>450</b>	450 mm	10 pares
0073.045AOT <b>500</b>	500 mm	10 pares
0073.045AOT <b>550</b>	550 mm	10 pares

## Corrediça Telescópica FGVTN TT 44 One-Touch



+no SITE



**Acabamento:** Zinco Acetinado

Código	Descrição	Emb.
0073.044 <b>350</b> OT	350 mm	10 pares
0073.044 <b>400</b> OT	400 mm	10 pares
0073.044 <b>450</b> OT	450 mm	10 pares
0073.044 <b>500</b> OT	500 mm	10 pares
0073.044 <b>550</b> OT	550 mm	10 pares

## Corrediça Telescópica FGVTN TT 35 One-Touch



+no SITE



**Acabamento:** Zinco Acetinado

Código	Descrição	Emb.
0073.035 <b>350</b> OT	350 mm	20 pares
0073.035 <b>400</b> OT	400 mm	20 pares
0073.035 <b>450</b> OT	450 mm	20 pares
0073.035 <b>500</b> OT	500 mm	20 pares
0073.035 <b>550</b> OT	550 mm	20 pares

## Corrediça Telescópica FGVTN TT 58 Self-Closing



+no SITE



**Acabamento:** Zinco eletrolítico cromatizado azul

Código	Descrição	Emb.
0073.058 <b>500</b>	500 mm	5 pares
0073.058 <b>600</b>	600 mm	5 pares

## Corrediça Telescópica **FGVTN TT 50 Self-Closing**



+no SITE



**Acabamento:**  
Zinco eletrolítico cromatizado azul

Código	Descrição	Emb.
0073.050 <b>400</b>	400 mm	10 pares
0073.050 <b>450</b>	450 mm	10 pares
0073.050 <b>500</b>	500 mm	10 pares
0073.050 <b>600</b>	600 mm	10 pares
0073.050 <b>650</b>	650 mm	10 pares

## Corrediça Telescópica **FGVTN TT 45 Self-Closing**



+no SITE

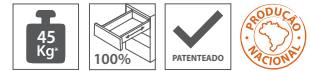

**Acabamento:** Zinco acetinado

Código	Descrição	Emb.
0073.045ASC <b>350</b>	350 mm	10 pares
0073.045ASC <b>400</b>	400 mm	10 pares
0073.045ASC <b>450</b>	450 mm	10 pares
0073.045ASC <b>500</b>	500 mm	10 pares
0073.045ASC <b>550</b>	550 mm	10 pares

## Corrediça Telescópica **FGVTN TT 45 com Engate**

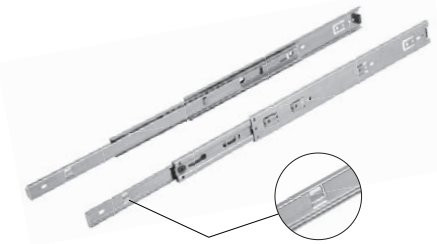

+no SITE

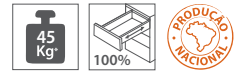

**Acabamento:** Zinco Acetinado

Código	Descrição	Emb.
0073.04ACE <b>350</b>	350 mm	10 pares
0073.04ACE <b>400</b>	400 mm	10 pares
0073.04ACE <b>450</b>	450 mm	10 pares

## Corrediça Telescópica **TT 45 TSI**



+no SITE

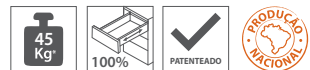

Código ZA	Descrição	Emb.
0073.045ATS <b>350</b>	350 mm	6/1 par
0073.045ATS <b>400</b>	400 mm	6/1 par
0073.045ATS <b>450</b>	450 mm	6/1 par

Código	Descrição	Emb.
0073.045 <b>275</b> TSI	Barra de interligação 275 mm	100/10 pares

\*Outras medidas sob consulta

## Corrediça Telescópica FGVTN TT 45



+no SITE

**Acabamento:** Zinco Acetinado

Código	Descrição	Emb.
0073.045A250	250 mm	10 pares
0073.045A300	300 mm	10 pares
0073.045A350	350 mm	10 pares
0073.045A400	400 mm	10 pares
0073.045A450	450 mm	10 pares
0073.045A500	500 mm	10 pares
0073.045A550	550 mm	10 pares
0073.045A600	600 mm	10 pares
0073.045A650	650 mm	10 pares
0073.045A700	700 mm	10 pares

## Corrediça Telescópica FGVTN H45



+no SITE

**Acabamento:** Zinco eletrolítico cromatizado azul

Código	Descrição	Emb.
54514508725015	250 mm	15 pares
54514508730015	300 mm	15 pares
54514508735015	350 mm	15 pares
54514508740015	400 mm	15 pares
54514508745015	450 mm	15 pares
54514508750015	500 mm	15 pares
54514508755015	550 mm	15 pares
54514508760015	600 mm	15 pares
54514508765015	650 mm	15 pares

## Corrediça Telescópica TN H45



+no SITE

**Acabamento:** Zinco eletrolítico cromatizado azul

Descrição	Emb.
TN H45 250 mm	10 pares
TN H45 300 mm	10 pares
TN H45 350 mm	10 pares
TN H45 400 mm	10 pares
TN H45 450 mm	10 pares
TN H45 500 mm	10 pares
TN H45 550 mm	10 pares
TN H45 600 mm	10 pares
TN H45 650 mm	10 pares
TN H45 700 mm	10 pares

\*Acabamento zincado preto sob consulta.

LANÇAMENTO

## Corrediça FGVTN Larga ZA



+no SITE

**Acabamento:** Zinco Acetinado

Código	Descrição	Emb.
545144FGV0250ZA	250 mm ZA	15 pares
545144FGV0300ZA	300 mm ZA	15 pares
545144FGV0350ZA	350 mm ZA	15 pares
545144FGV0400ZA	400 mm ZA	15 pares
545144FGV0450ZA	450 mm ZA	15 pares
545144FGV0500ZA	500 mm ZA	15 pares

## Corrediça Telescópica FGVTN H35



+no SITE

**Acabamento:** Zinco eletrolítico cromatizado azul

\*Acabamento zincado preto sob consulta

Código	Descrição	Emb.
53513508725020	250 mm	20 pares
53513508730020	300 mm	20 pares
53513508735020	350 mm	20 pares
53513508740020	400 mm	20 pares
53513508745020	450 mm	20 pares
53513508750020	500 mm	20 pares
53513508755020	550 mm	20 pares

## Corrediça Telescópica TN Mini H35

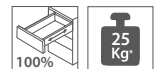

+no SITE

**Acabamento:** Zinco eletrolítico cromatizado azul

Código	Descrição	Emb.
535TN077LT25020	250 mm	20 pares
535TN077LT30020	300 mm	20 pares
535TN077LT35020	350 mm	20 pares
535TN077LT40020	400 mm	20 pares
535TN077LT45020	450 mm	20 pares
535TN077LT50020	500 mm	20 pares
535TN077LT55020	550 mm	20 pares
535TN077LT60020	600 mm	20 pares

## Corrediça Simples de Roldanas TTS 082



+no SITE

**Acabamento:** Pintura eletrostática epóxi branco, preto ou cinza

Descrição	Emb.
082 250mm	50 pares
082 300mm	50 pares
082 350mm	50 pares
082 400mm	50 pares
082 450mm	50 pares
082 500mm	50 pares

## Acessório para Corrediça 082 Calço 082 25/30 mm

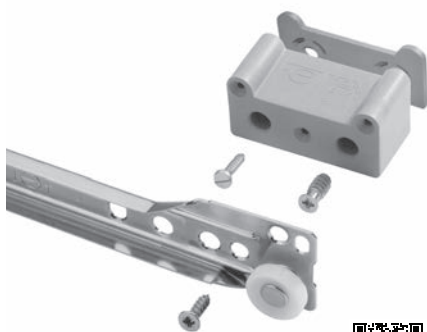

+no SITE

Código	Descrição	Acab.	Emb.
0074.000251	Calço 082 25 mm	Branco	1.000 pçs.
0074.000253	Calço 082 25 mm	Preto	1.000 pçs.
0074.000256	Calço 082 25 mm	Cinza	1.000 pçs.
0074.000301	Calço 082 30 mm	Branco	750 pçs.
0074.000303	Calço 082 30 mm	Preto	750 pçs.
0074.000306	Calço 082 30 mm	Cinza	750 pçs.

Código	Descrição	Acab.	Emb.
0074.000021	Sobrecalço 082 2 mm	Branco	2.000 pçs.
0074.000023	Sobrecalço 082 2 mm	Preto	2.000 pçs.
0074.000026	Sobrecalço 082 2 mm	Cinza	2.000 pçs.



Corrediça Telescópica

**TN H45 Inox**

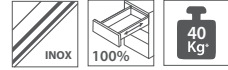

+no SITE

Acabamento: Aço inox 201

Código	Descrição	Emb.
545TN08SS35010	350 mm	10 pares
545TN08SS40010	400 mm	10 pares
545TN08SS45010	450 mm	10 pares
545TN08SS50010	500 mm	10 pares
545TN08SS55010	550 mm	10 pares

Corrediça Telescópica FGVTN  
**H45 Inox Slowmotion**

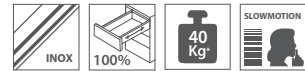

+no SITE

Acabamento: Aço inox 201

Código	Descrição	Emb.
545FCX08SS35010	350 mm	10 pares
545FCX08SS40010	400 mm	10 pares
545FCX08SS45010	450 mm	10 pares
545FCX08SS50010	500 mm	10 pares
545FCX08SS55010	550 mm	10 pares

**SAIBA +**

**ESCOLHA  
A CORREDIÇA  
TELESCÓPICA  
CERTA!**

**GAVETÕES**

- Corrediça Telescópica FGVTN TT 45
- Corrediça Telescópica FGVTN TT 45 Slowmotion
- Corrediça Telescópica FGVTN TT 45 One-Touch
- Corrediça Telescópica FGVTN TT 45 Self-Closing
- Corrediça Telescópica FGVTN TT 45 com Engate
- Corrediça Telescópica FGVTN TT 50 Self-Closing
- Corrediça Telescópica TT 58 Self-Closing



**PRINCIPAIS VANTAGENS:** Maior capacidade de carga e modelos para gavetas largas e pesadas.

**REGIÕES DE MARESIÁ,  
ARMAZENAMENTO DE MATERIAIS  
DE LIMPEZA, TEMPEROS E  
AMBIENTES FRIGORIFICADOS**



Corrediça Telescópica FGVTN  
H45 Inox Slowmotion

Corrediça Telescópica TN H45 Inox

**QUADROS PARA  
PASTAS SUSPENSAS (PÁG. 71)**

Corrediça Telescópica TT 45 TSI





LANÇAMENTO

Dobradiça FGVTN  
**Click 3D Slow**



+ no SITE



**Acabamento:** Aço niquelado  
**Profundidade do caneco:** 11,3 mm  
**Diâmetro do Caneco:** 35 mm  
**Espessura da porta:** 15 a 22 mm

Código	Descrição	Emb.
51MX153DRV00100	Reta Calço 0 Completa	10/100 pçs.
51MX153DRV08100	Curva Calço 0 Completa	10/100 pçs.
51MX153DRV15100	Alta Calço 0 Completa	10/100 pçs.

Código Ind.	Descrição	Emb.
51MX15FG1100SC	Reta s/ calço	100 pçs.
51MX15FG1108SC	Curva s/ calço	100 pçs.
51MX15FG1115SC	Alta s/ calço	100 pçs.

Código Ind.	Descrição	Emb.
52MX15FG11003D	Calço 3D 0mm	400/50 pçs.
52MX15FG1111IN	Tampa Met. p/ Corpo	400/50 pçs.
52MX15FG1112IN	Tampa Met. p/ Caneco	400/50 pçs.

Dobradiça FGVTN  
**Click Slow**



+ no SITE

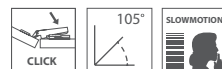

**Acabamento:** Aço niquelado  
**Diâmetro do caneco:** 35 mm  
**Profundidade do caneco:** 11,3 mm  
**Espessura da porta:** de 16 a 26 mm  
**Observações:** Acompanha dobradiça / Calço 2 mm / Tampa para cobertura do corpo e caneco / Parafusos

Código	Descrição	Emb.
51MX15FG1100B10	Reta completa	100/10 conj.
51MX15FG1108B10	Curva completa	100/10 conj.
51MX15FG1115B10	Alta completa	100/10 conj.

Código	Descrição	Emb.
52MX15TN1100100	Calço 0 mm	400/50 peças
52MX15TN1102100	Calço 2 mm	400/50 peças
52MX15TN1104100	Calço 4 mm	400/50 peças



Dobradiça Easy **TN****Click Slow Inox Calço Duplo**

**Acabamento:** Aço inox  
**Diâmetro do caneco:** 35 mm  
**Profundidade do caneco:** 11,3 mm  
**Espessura da porta:** de 16 a 20 mm  
**Observações:** Acompanha dobradiça / Calço inox 0 mm / Tampa inox para cobertura do corpo e caneco / Parafusos inox



+no SITE

Código	Descrição	Emb.
51MX15TNSS000CD	Reta	50/2 peças
51MX15TNSS008CD	Curva	50/2 peças
51MX15TNSS015CD	Alta	50/2 peças

Nova Dobradiça **TN****Click Slow**

**Acabamento:** Aço niquelado  
**Diâmetro do caneco:** 35 mm  
**Profundidade do caneco:** 11,3 mm  
**Espessura da porta:** de 14 a 20 mm  
**Observações:** Acompanha dobradiça / Calço 0 mm (reta, curva e alta) / Calço 2 mm (reta)



+no SITE

Código	Descrição	Emb.
51MX15TN4700100	Reta H0	20 pares
51MX15TN4700102	Reta H2	20 pares
51MX15TN4708100	Curva H0	20 pares
51MX15TN4715100	Alta H0	20 pares

**SAIBA +****CALÇO 3D**

- Montagem fácil com o sistema de regulagem 3D para ajustes rápidos e precisos.
- Também vendido separadamente.



Dobradiça **TN**  
**Click Slow Easy**



+no SITE

**Acabamento:** Aço níquelado  
**Diâmetro do caneco:** 35 mm  
**Profundidade do caneco:** 11,3 mm  
**Espessura da porta:** de 16 a 26 mm  
**Observações:** Acompanha dobradiça / Calço 0 mm (reta) e calço 2 mm (curva e alta) / Tampa para cobertura do corpo e caneco / Parafusos

Código	Descrição	Emb.
51MX15TN1200B10	Reta	100/10 conj.
51MX15TN1208B10	Curva	100/10 conj.
51MX15TN1215B10	Alta	100/10 conj.

LANÇAMENTO

Dobradiça **FGVTN**  
**Click 3D Slow Móveis em Ângulo**

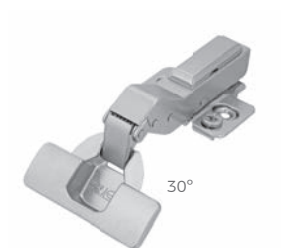

30°

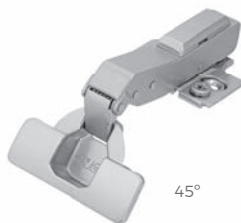

45°



90°



+no SITE



**Acabamento:** Aço níquelado  
**Diâmetro do Caneco:** 35 mm  
**Profundidade do caneco:** 11,3 mm  
**Espessura da porta:** 15 a 22 mm

Código	Descrição	Emb.
51MX85FG113D302	30° Completa	50/2 pçs.
51MX85FG113D452	45° Completa	50/2 pçs.
51MX85FG113D902	90° Completa	50/2 pçs.
51MX15FG1130SC	30° s/ calço	100 pçs.
51MX15FG1145SC	45° s/ calço	100 pçs.
51MX15FG1190SC	90° s/ calço	100 pçs.

Código	Descrição	Emb.
52MX15FG11003D	Calço 3D 0mm p/ Dobr. FGVTN Click Slow	400/10 pçs.
52MX15FG1111IN	Tampa Metálica p/ Corpo Dobr. FGVTN Click Slow	2.000 pçs.
52MX15FG1112IN	Tampa Metálica p/ Caneco Dobr. FGVTN Click Slow	1.000 pçs.

LANÇAMENTO

Dobradiça FGVTN

## Click 3D Slow Móveis em Ângulo 165°



+no SITE

**Acabamento:** Aço niquelado  
**Diâmetro do Caneco:** 35 mm  
**Profundidade do caneco:** 11,3 mm  
**Espessura da porta:** 15 a 22 mm

Código	Descrição	Emb.
51MX85FG113DC65	Curva 165° Completa	20/1 pçs.
51MX85FG113DR65	Reta 165° Completa	20/1 pçs.
51MX15FG165CSC	Curva 165° s/ calço	50 pçs.
51MX15FG165RSC	Reta 165° s/ calço	50 pçs.

Código	Descrição	Emb.
52MX15FG11003D	Calço 3D 0mm p/ Dobr. FGVTN Click Slow	400/50 pçs.

Dobradiça FGVTN

## Click Slowmotion Móveis em Ângulo



+no SITE



**Acabamento:** Aço niquelado  
**Diâmetro do caneco:** 35 mm  
**Profundidade do caneco:** 11,3 mm  
**Espessura da porta:** de 16 a 26 mm  
**Observações:** Acompanha dobradiça / Calço 0 mm / Tampa para cobertura do corpo e caneco / Parafusos

Código	Descrição	Emb.
51MX85FG1100302	Completa 30°	50/2 conj.
51MX85FG1100452	Completa 45°	50/2 conj.
51MX85FG1100902	Completa 90°	50/2 conj.

Dobradiça FGVTN

## Click Slowmotion 165° Móveis em Ângulo



+no SITE

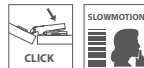

**Acabamento:** Aço niquelado  
**Diâmetro do caneco:** 35 mm  
**Profundidade do caneco:** 11,3 mm  
**Espessura da porta:** de 16 a 26 mm  
**Observações:** Sistema de montagem com calço M Click / Acompanha dobradiça / Calço 0 mm / Parafusos

Código	Descrição	Emb.
51MX85FG11R1652	Reta 165° completa	20/1 conj.
51MX85FG11C1652	Curva 165° completa	20/1 conj.

Código	Descrição	Emb.
52MX15TN1100100	Calço 0 mm	400/50 pçs.
52MX15TN1102100	Calço 2 mm	400/50 pçs.
52MX15TN1104100	Calço 4 mm	400/50 pçs.

### LANÇAMENTO

Dobradiça FGVTN

## Click Slow Reta 155° Zero PR

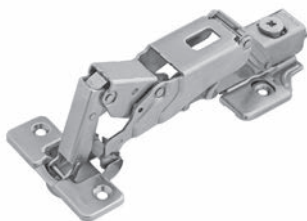

+no SITE

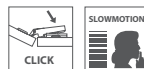

**Acabamento:** Aço niquelado  
**Diâmetro do Caneco:** ø35  
**Profundidade do caneco:** 11,3 mm  
**Espessura da porta:** 16 a 26 mm  
**Observações:** Calço 3D 0 mm montado à dobradiça

Código	Descrição	Emb.
51MX85FG1550020	Reta 155° completa	20 peças

## Dobradiça MS Slow Next FGVTN



+no SITE



**Acabamento:** Aço niquelado  
**Diâmetro do caneco:** 35 mm  
**Profundidade do caneco:** 9,5 mm  
**Diâmetro do caneco:** 35 mm  
**Espessura da porta:** de 12 a 20 mm  
**Observações:** Acompanha dobradiça / Calço 2 mm (reta e curva) / Calço 0 mm (alta)

Código	Descrição	Emb.
51MS15XFG1200NX	Reta H2	100 peças
51MS15XFG1208NX	Curva H2	100 peças
51MS15XFG1215NX	Alta H0	100 peças

## Dobradiça **TN** MS Slow Easy



+no SITE



**Acabamento:** Aço niquelado  
**Diâmetro do caneco:** 35 mm  
**Profundidade do caneco:** 11,3 mm  
**Espessura da porta:** de 16 a 26 mm  
**Observações:** Acompanha dobradiça / Calço 2 mm (reta e curva) / Calço 0 mm (alta) / Tampa para cobertura do corpo

Código	Descrição	Emb.
51MS15XTN1200B0	Reta	100 conj.
51MS15XTN1208B0	Curva	100 conj.
51MS15XTN1215B0	Alta	100 conj.

## Dobradiça FGVTN MS Slow

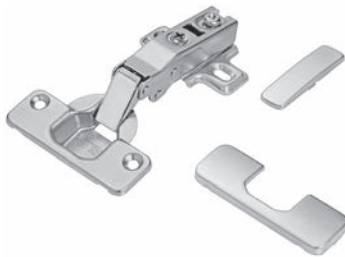

+no SITE



**Acabamento:** Aço niquelado  
**Diâmetro do caneco:** 35 mm  
**Profundidade do caneco:** 11,3 mm  
**Espessura da porta:** de 16 a 26 mm  
**Observações:** Acompanha dobradiça / Calço 0 mm (curva e alta) e calço 4 mm (reta) / Tampa para cobertura do corpo e caneco / Parafusos

Código	Descrição	Emb.
51MS15XFC100B10	Reta completa	100/10 conj.
51MS15XFC108B10	Curva completa	100/10 conj.
51MS15XFC115B10	Reta completa	100/10 conj.

Código	Descrição	Emb.
52MS15XTN010000	Calço 0 mm	500 peças
52MS15XTN010200	Calço 2 mm	500 peças
52MS15XTN010400	Calço 4 mm	500 peças

## Dobradiça **TN** Inox Slowmotion



+no SITE



**Acabamento:** Aço inox  
**Diâmetro do caneco:** 35 mm  
**Profundidade do caneco:** 11,3 mm  
**Espessura da porta:** de 16 a 26 mm  
**Observações:** Acompanha dobradiça / Calço 2 mm / Tampa inox para cobertura do corpo e caneco / Parafusos inox

Código	Descrição	Emb.
51MS15TNSX00050	Reta completa	50/2 conj.
51MS15TNSX08050	Curva completa	50/2 conj.
51MS15TNSX15050	Alta completa	50/2 conj.

## DOBRADIÇAS

LANÇAMENTO

Dobradiça **TN**

### MS Slow Calço Duplo



+no SITE

**Acabamento:** Aço níquelado  
**Diâmetro do Caneco:** 35 mm  
**Profundidade do caneco:** 11,3 mm  
**Espessura da porta:** 12 a 22 mm  
**Observações:** Caixa master com 200 dobradiças com calço montado

Código	Descrição	Emb.
51MS15XTN490010	MS Slow Reta Calço Duplo	200 peças
51MS15XTN490810	MS Slow Curva Calço Duplo	200 peças
51MS15XTN491510	MS Slow Alta Calço Duplo	200 peças

Dobradiça

### Série M Slide-On 110°



+no SITE

**Acabamento:** Aço níquelado  
**Diâmetro do caneco:** 35 mm  
**Profundidade do caneco:** 11,3 mm  
**Espessura da porta:** de 16 a 26 mm  
**Observação:** Calço vendido separadamente  
**Observações:** Acompanha dobradiça / Calço vendido separadamente (ver página 5) / Opção de venda em kit

Código	Descrição	Emb.
51MS150500A00	Reta	250 peças
51MS150508A00	Curva	250 peças
51MS150515A00	Alta	250 peças

Embalagem Kits (dobradiças, calços e parafusos)

Código	Descrição	Emb.
51MS150500A10	Kit Dob. MS15 Reta 110° Completa	150/10 kit
51MS150508A10	Kit Dob. MS15 Curva 110° Completa	150/10 kit
51MS150515A10	Kit Dob. MS15 Alta 110° Completa	150/10 kit

**FGVTN,  
A MAIOR  
LINHA DE  
DOBRADIÇAS  
DO MERCADO.**

- Dobradiças Slide-On Slowmotion
- Dobradiças Click Slowmotion
- Dobradiças 3D
- Dobradiças Slide-On
- Dobradiças Abertura Automática
- Dobradiças Mini
- Dobradiças para Portas Basculantes

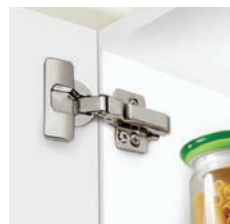

## Dobradiça MS Abertura Automática



**Acabamento:** Aço niquelado  
**Diâmetro do caneco:** 35 mm  
**Profundidade do caneco:** 11,3 mm  
**Espessura da porta:** de 16 a 26 mm  
**K:** de 3 a 7 mm

**Observações:** Acompanha dobradiça / Calço vendido separadamente (ver página 5) / Opção de venda em kit / Indicado aplicação com o sistema de Fecho Toque ou Pulsador Magnético



+no SITE

Código	Descrição	Emb.
51MS15P5000000	Reta	250 peças
51MS15P50000AB	Reta	50 peças
51MS15P5080000	Curva	250 peças
51MS15P508000AB	Curva	50 peças
51MS15P5150000	Alta	250 peças
51MS15P515000AB	Alta	50 peças

Código	Descrição	Emb.
51MS15P5000R01	Kit MS15 Reta Abert. Automática 110° 10 Dob.+10 Calço 2+10 Calço 4+40 Paraf.	10 kits
51MS15P5080R01	Kit MS15 Curva Abert. Automática 110° 10 Dob.+10 Calço 2+10 Calço 4+40 Paraf.	10 kits
51MS15P5150R01	Kit MS15 Alta Abert. Automática 110° 10 Dob.+10 Calço 2+10 Calço 4+40 Paraf.	10 kits

## Dobradiça MS Sem Mola



**Acabamento:** Aço niquelado  
**Diâmetro do caneco:** 35 mm  
**Profundidade do caneco:** 11,3 mm  
**Espessura da porta:** de 16 a 26 mm  
**Observações:** Acompanha dobradiça / Calço vendido separadamente (ver página 5)



+no SITE

Código	Descrição	Emb.
51MS050500000	Reta s/ mola	250 peças
51MS0505000AB	Reta s/ mola	50 peças
51MS050508000	Curva s/ mola	250 peças
51MS05050800AB	Curva s/ mola	50 peças
51MS050515000	Alta s/ mola	250 peças
51MS05051500AB	Alta s/ mola	50 peças

Dobradiça

## Série M Slide-On Portas de Alumínio

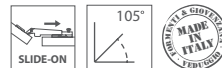

**Acabamento:** Aço niquelado  
**Distância entre furos do caneco:** 28 mm  
**Perfis de alumínio:** de 19 a 25 mm  
**Observações:** Acompanha dobradiça / Calço vendido separadamente (ver página 5) / Opção de venda em kit

Código	Descrição	Emb.
51MS410500000	Reta	250 peças
51MS4105000AB	Reta	50 peças
51MS410508000	Curva	250 peças
51MS4105080AB	Curva	50 peças
51MS410515000	Alta	250 peças
51MS4105150AB	Alta	50 peças



+no SITE

Código	Descrição	Emb.
51MS410500R01	MS41 Reta 105° p/ Alumínio 2 Dob. + Calço 2 + 2 Calço 4 + 8 Paraf.	50 kits
51MS410508R01	MS41 Curva 105° p/ Alumínio 2 Dob. + 2 Calço 2 + 2 Calço 4 + 8 Paraf.	50 kits
51MS410515R01	MS41 Alta 105° p/ Alumínio 2 Dob. + 2 Calço 2 + 2 Calço 4 + 8 Paraf.	50 kits

Dobradiça para

## Portas Basculantes

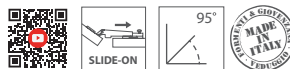

+no SITE

**Acabamento:** Aço niquelado  
**Diâmetro do caneco:** 35 mm  
**Profundidade do caneco:** 11,3 mm  
**Espessura da porta:** de 16 a 26 mm  
**Observações:** Acompanha dobradiça lado esquerdo ou direito / Calço vendido separadamente (ver página 5) / Opção de venda em kit

Código	Descrição	Emb.
51MN57L500000	MN57 Esq. p/ Porta Basculante 95°	250 peças
51MN57R500000	MN57 Dir. p/ Porta Basculante 95°	250 peças
51MN57RL500R01	Kit MN57 p/ Porta Basculante 95° 1 Esq. + 1 Dir. + 2 Calços 6 + 8 Paraf.	50 kits

Dobradiça

## TN Inox

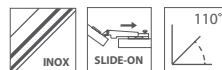

+no SITE

**Acabamento:** Aço inox  
**Diâmetro do caneco:** 35 mm  
**Profundidade do caneco:** 11,3 mm  
**Espessura da porta:** de 16 a 26 mm  
**Observações:** Acompanha dobradiça / Calço inox 0 mm / Parafusos inox

Código	Descrição	Emb.
51MS15TNS500050	Reta	50/2 pçs.
51MS15TNS508050	Curva	50/2 pçs.
51MS15TNS515050	Alta	50/2 pçs.



## Dobradiça TN Slide-On Calço Duplo



+no SITE

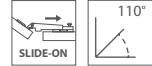

**Acabamento:** Aço niquelado  
**Diâmetro do Caneco:** 35 mm  
**Profundidade do caneco:** 11,3 mm  
**Espessura da porta:** 16 a 20 mm  
**Observações:** Acompanha dobradiça / Calço 2 mm

Código	Descrição	Emb.
51MS15TN2200200	Reta Calço Duplo	50/200 peças
51MS15TN2208200	Curva Calço Duplo	50/200 peças
51MS15TN2215200	Alta Calço Duplo	50/200 peças

## Dobradiça QS Mini FGV



+no SITE



**Acabamento:** Aço niquelado  
**Diâmetro do caneco:** 26 mm  
**Profundidade do caneco:** 9,8 mm  
**Espessura da porta:** de 12 a 18 mm  
**Observações:** Acompanha dobradiça / Calço vendido separadamente (ver página 5) / Opção de venda completa (dobradiça + calço)

Código	Descrição	Emb.
51QS15050002000	FGV Mini Reta Industrial	500 peças
51QS15050002R10	FGV Mini Reta 250/10 Completa	250/10 conj.
51QS15050802000	FGV Mini Curva Industrial	500 peças
51QS15050802R10	FGV Mini Curva 250/10 Completa	250/10 conj.
51QS15051502000	FGV Mini Alta Industrial	500 peças
51QS15150002R10	FGV Mini Alta 250/10 Completa	250/10 conj.
520301M502100	Calço Cruz 2 mm p/ Dob. Mini FGV	500 peças
520301M504100	Calço Cruz 4 mm p/ Dob. Mini FGV	500 peças

### LANÇAMENTO

## Dobradiça TN Mini HB



+no SITE

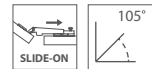

**Acabamento:** Aço niquelado  
**Diâmetro do Caneco:**  $\phi 26$   
**Profundidade do caneco:** 8,5 mm  
**Observações:** Acompanha dobradiça / Opção de venda completa (dobradiça + calço)

Código	Descrição	Emb.
51QS15TN5100500	TN MINI HB Reta	500 peças
51QS15TN5108500	TN MINI HB Curva	500 peças
51QS15TN0031000	Calço TN MINI HB H3	1.000 peças
51QS15TN0051000	Calço TN MINI HB H5	1.000 peças
51QS15TN0121000	Calço TN MINI HB H12	1.000 peças

Dobradiças

Série M Slide-On Móveis em Ângulo



Móveis em ângulo 24°/30°  
Indicação de calço: 4 mm



+no SITE



Móveis de canto  
Indicação de calço: 2 mm



Móveis em ângulo 45°  
Indicação de calço: 4 mm



Móveis em ângulo cego 90°  
Indicação de calço: 4 mm

**Acabamento:** Aço niquelado  
**Diâmetro do caneco:** 35 mm  
**Profundidade do caneco:** 11,3 mm  
**Espessura da porta:** de 16 a 26 mm  
**Observações:** Acompanha dobradiça / Calço vendido separadamente (ver página 5) / Opção de venda em kit

Código	Descrição	Emb.
51MS83M535000	MS83 para Canto	250 peças
51MS83M5350AB	MS83 para Canto	50 peças
51MS8505300A000	MS85 Módulo A 24/30°	250 peças
51MS8505300AB	MS85 Módulo A 24/30°	50 peças
51MS8505450A000	MS85 Módulo A 45°	250 peças
51MS8505450AB	MS85 Módulo A 45°	50 peças
51MS8505900A000	MS85 Ângulo Cego	250 peças
51MS8505900AB	MS85 Ângulo Cego	50 peças
51MS83RE35000	Reta 175° + Canto Completa	20 kits
51MS83RE36000	Curva 175° + Canto Completa	20 kits
51MS85RE45000	Módulo A 45° Completa	30 kits

Dobradiça Série M  
Slide-On 175°

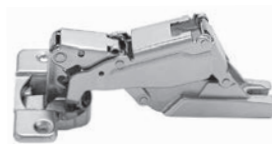

+no SITE

**Acabamento:** Aço niquelado  
**Diâmetro do caneco:** 35 mm  
**Profundidade do caneco:** 11,3 mm  
**Espessura da porta:** de 16 a 26 mm  
**Observações:** Acompanha dobradiça / Calço vendido separadamente (ver página 5)

Código	Descrição	Emb.
51MW150500000	175° Reta	125 peças
51MW1505000AB	175° Reta	50 peças
51MW150508000	175° Curva	125 peças
51MW1505080AB	175° Curva	50 peças

Dobradiça  
**TN 165°**

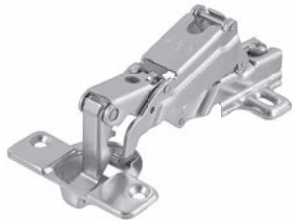

+no SITE

**Acabamento:** Aço niquelado  
**Diâmetro do caneco:** 35 mm  
**Profundidade do caneco:** 11,3 mm  
**Espessura da porta:** de 16 a 26 mm  
**Observações:** Acompanha dobradiça / Calço 0 mm / Parafusos

Código	Descrição	Emb.
51MW15TN0316050	Reta	50/10 pçs.
51MW15TN0316850	Curva	50/10 pçs.

Dobradiça **TN**  
**Móveis em Ângulo -45°**

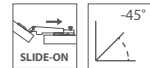

+no SITE

**Acabamento:** Aço niquelado  
**Diâmetro do caneco:** 35 mm  
**Profundidade do caneco:** 11,3 mm  
**Espessura da porta:** de 16 a 26 mm  
**Observações:** Acompanha dobradiça / Calço 4 mm

Código	Descrição	Emb.
51MK85TN1245050	Âng. -45°	50 pçs.

Dobradiça **TN**  
**Mini 45°**

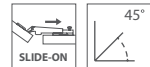

+no SITE

**Acabamento:** Aço niquelado  
**Diâmetro do caneco:** 26 mm  
**Profundidade do caneco:** 8,5 mm  
**Espessura da porta:** de 12 a 18 mm  
**Observações:** Acompanha dobradiça / Calço 0 mm

Código	Descrição	Emb.
51QS15TN1245100	Dobradiça Mini 45° com calço	100 conj.

## Dobradiça FGVTN MS Slow Calço Fixo



+no SITE

**Acabamento:** Aço niquelado  
**Diâmetro do caneco:** 35 mm  
**Profundidade do caneco:** 9.5 mm  
**Espessura da porta:** de 12 a 20 mm  
**Observações:** Acompanha dobradiça / Calço 2 mm (curva e alta) / Calço 4 mm (reta)

Código	Descrição	Emb.
51MS15XFG0100BF	Reta	100 conj.
51MS15XFG0108BF	Curva	100 conj.
51MS15XFG0115BF	Reta	100 conj.

## Dobradiça TN MS Slow Calço Fixo



+no SITE

**Acabamento:** Aço niquelado  
**Diâmetro do caneco:** 35 mm  
**Espessura da porta:** de 12 a 20 mm  
**Observações:** Acompanha dobradiça / Calço 0 mm

Código	Descrição	Emb.
51MS15XTN2200BF	Reta	100 conj.
51MS15XTN2208BF	Curva	100 conj.
51MS15XTN2215BF	Alta	100 conj.

SAIBA +

INSTALAÇÃO  
RÁPIDA

GABARITOS  
DE INSTALAÇÃO

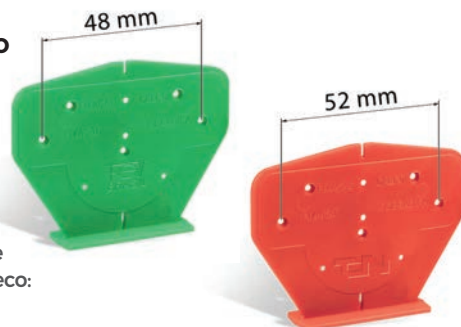

• Distância entre os furos do caneco:  
**FGVTN: 48 mm**  
**TN: 52 mm**

+ no SITE: Catálogos, manuais de instalação e desenhos técnicos



LANÇAMENTO

## Prateleira Vidro Sense



+no SITE

**Material:** Perfis das corredeiras em aço laminado zincado e componentes conjugados em diversos materiais.

Código	Descrição	Emb.
55AR00128600	Prateleira Vidro Sense 600 mm	1 kit
55AR00128900	Prateleira Vidro Sense 900 mm	1 kit

LANÇAMENTO

## Calceiro Sense



+no SITE

**Material:** Perfis das corredeiras em aço laminado zincado e componentes conjugados em diversos materiais.

Código	Descrição	Emb.
55AR00122600	Calceiro Sense 600 mm	1 kit
55AR00122900	Calceiro Sense 900 mm	1 kit

LANÇAMENTO

## Cesto Vime Sense



+no SITE

**Material:** Perfis das corrediças em aço laminado zincado e componentes conjugados em diversos materiais.

Código	Descrição	Emb.
55AR00119600	Cesto Vime Sense 600 mm	1 kit
55AR00119900	Cesto Vime Sense 900 mm	1 kit



LANÇAMENTO

## Sapateira Sense



+no SITE

**Material:** Perfis das corrediças em aço laminado zincado e componentes conjugados em diversos materiais.

Código	Descrição	Emb.
55AR00126600	Sapateira Sense 600 mm	1 kit
55AR00126900	Sapateira Sense 900 mm	1 kit



LANÇAMENTO

## Porta-Jóias Sense



+no SITE

**Material:** Perfis das corrediças em aço laminado zincado e componentes conjugados em diversos materiais.

Código	Descrição	Emb.
55AR00117600	Porta-Jóias Sense 600 mm	1 kit
55AR00117900	Porta-Jóias Sense 900 mm	1 kit



LANÇAMENTO

## Cesto Metálico Sense



+no SITE

**Material:** Perfis das corredeças em aço laminado zincado e componentes conjugados em diversos materiais. Disponível em 2 alturas: H80 e H130.

Código	Descrição	Emb.
55AR0012060A	Cesto Metálico Sense 600 mm H80	1 kit
55AR0012060B	Cesto Metálico Sense 600 mm H130	1 kit
55AR0012090A	Cesto Metálico Sense 900 mm H80	1 kit
55AR0012090B	Cesto Metálico Sense 900 mm H130	1 kit

LANÇAMENTO

## Organizador em Madeira Sense



+no SITE

**Material:** Perfis das corredeças em aço laminado zincado e componentes conjugados em diversos materiais.

Código	Descrição	Emb.
55AR00118900	Organizador em Madeira Sense 900 mm	1 kit

SAIBA +

LINHA  
*Sense*  
by FCVTN

ACABAMENTOS QUE REALÇAM A BELEZA DE CADA ESPAÇO, COM DESIGN, REQUINTE E SOFISTICAÇÃO.



PINTURA EPÓXI  
MARROM

MADEIRA

VIDRO

VELUDO

Tábua de Passar  
**TP 450**



+no SITE

Código	Descrição	Emb.
0072.972145	TP 450 Branca	1 conj.
0072.972146	TP 450 Cinza Cromo	1 conj.
0072.972148	Tampo Revestido p/ TP 450	1 peça
0072.972149	Forro Térmico p/ TP 450	1 peça

Tábua de Passar  
**TP 480**



+no SITE

Código	Descrição	Emb.
0072.972150	TP 480 Branca	1 conj.
0072.972153	TP 480 Cinza Cromo	1 conj.
0072.972148	Tampo Revestido p/ TP 480	1 peça
0072.972152	Forro Térmico p/ TP 480	1 peça

Tábua de Passar  
**TP 800**



+no SITE

Código	Descrição	Emb.
0072.972140	TP 800 Cinza	1 conj.
0072.972142	TP 800 Cinza Cromo	1 conj.
0072.972141	Forro Térmico p/ TP 800	1 peça



## Easy Shelf Prateleira Basculante



+no SITE

**Acabamento:** Pintura cinza

Cód.	Descrição	"L" (mm)	Emb.
55PB00600320	Easy Shelf 600x320	600	1 conj.
55PB00900320	Easy Shelf 900x320	900	1 conj.

## Canto Articulado FGVTN Slow



+no SITE

**Material:** Aço Cromado e MDF branco

Cód.	Descrição	Emb.
55CA00901DIR	Canto Direito 900x450x500mm	1 conj.
55CA00901ESQ	Canto Esquerdo 900x450x500mm	1 conj.

## Lixeira Automática FGVTN



+no SITE

**Material:** Corpo em aço inox e cuba plástica

**Acabamento:** Inox brilhante 201

**Fixação:** Lateral por meio de parafusos

Cód.	Descrição	Emb.
590PAFG101204	Lixeira Auto. FGVTN Inox	4/1 un.

## Calceiro Deslizante CD 135

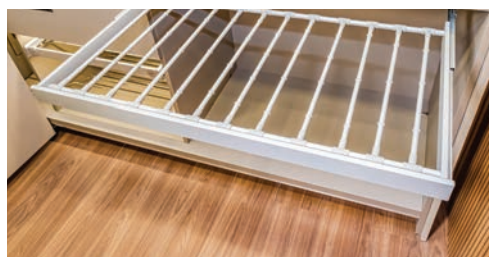
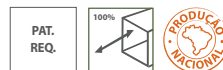

**Material:** Corrediça telescópica em aço relaminado, corpo e varetas em aço carbono

**Acabamento:** Alumínio fosco ou cinza cromo

**Fixação:** Na lateral ou na parte inferior de tampos

Ref.	Nº Varetas	Cód. Cinza Cromo	Cód. Alumínio Fosco	Emb.
600	07	0072.972 <b>309</b>	0072.972 <b>314</b>	1 conj.
700	09	0072.972 <b>311</b>	0072.972 <b>315</b>	1 conj.
800	10	0072.972 <b>312</b>	0072.972 <b>316</b>	1 conj.
900	12	0072.972 <b>310</b>	0072.972 <b>317</b>	1 conj.
1.000	14	0072.972 <b>313</b>	0072.972 <b>318</b>	1 conj.



+no SITE

## Calceiro Deslizante CD

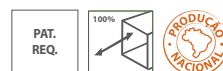

CD 400  
(10 varetas)



CD 450  
(12 varetas)



+no SITE

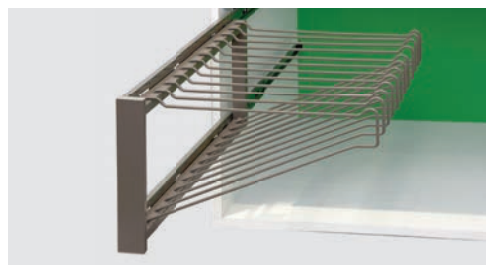

**Material:** Aço relaminado, tubo e arame de aço

**Varetas por módulo:** 10 ou 12 varetas metálicas móveis

**Acabamento:** Cinza cromo, cromado ou pintura alumínio fosco

**Fixação:** Lateral direita ou esquerda, com parafusos cabeça panela PHS AA 3,5 x 14mm

Cód.	Descrição	Emb.
0072.972 <b>319</b>	CD 400 mm Cinza Cromo	1 conj.
0072.972 <b>320</b>	CD 400 mm Alumínio Fosco	1 conj.
0072.972 <b>322</b>	CD 400 mm Cromado	1 conj.
0072.972 <b>299</b>	CD 450 mm Cinza Cromo	1 conj.
0072.972 <b>300</b>	CD 450 mm Alumínio Fosco	1 conj.
0072.972 <b>302</b>	CD 450 mm Cromado	1 conj.

Medida Corrediça	Nº Varetas
400 mm	10 varetas
450 mm	12 varetas

Calceiro  
**SPIN**



**Material:** Aço laminado e arame de aço

**Acabamento:** Cinza cromo, cromado ou pintura alumínio fosco

**Fixação:** Lateral com parafusos cabeça panela PHS AA 3,5 x 14mm



+no SITE

Cód.	Descrição	Emb.
0072.972212	Calceiro Spin Cinza Cromo	1 conjunto
0072.972213	Calceiro Spin Alumínio Fosco	1 conjunto
0072.972217	Calceiro Spin Cromado	1 conjunto

LANÇAMENTO

Cabideiro  
**SPIN**



**Material:** Aço relaminado e componentes plásticos em nylon

**Acabamento:** Pintura epóxi branco, cinza cromo e alumínio fosco

**Fixação:** Parafuso cabeça panela 3,5x25 e bucha S5



+no SITE

Cód.	Descrição	Emb.
0072.972410	Cabideiro Spin Branco	1 conjunto
0072.972411	Cabideiro Spin Cinza Cromo	1 conjunto
0072.972412	Cabideiro Spin Alumínio Fosco	1 conjunto

## Kit Escorredor

de Louças FGVTN

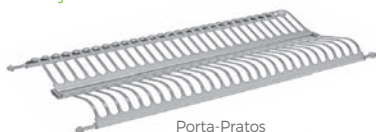

Porta-Pratos

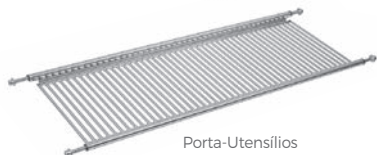

Porta-Utensílios



Bandeja



+no SITE



**Material:** Aço Inox 201

Código	Descrição	Emb.
566FG10600B00	Kit Base 600 - 20 pratos	1 conj.
566FG10800B00	Kit Base 800 - 28 pratos	1 conj.
566FG10900B00	Kit Base 900 - 32 pratos	1 conj.
566FG101000B0	Kit Base 1.000 - 36 pratos	1 conj.

## Ferragem Deslizante para Mesa de Embutir TT 10 302



+no SITE

**Material:** Aço relaminado estrutural  
**Fixação:** Lateral e apoiada com parafusos  
 Fixer 3,5 mm cabeça panela

Código	Descrição	Emb.
0072.972062	TT 10/302 480x800 mm Branco	1 par/cx.
0072.972063	TT 10/302 480x800 mm Cinza Cromo	1 par/cx.

## Prato Giratório

PG 1012



+no SITE

**Material:** Aço laminado  
**Acabamento:** Zinco eletrolítico cromatizado azul  
**Fixação:** Com bucha plástica 10 mm

Código	Descrição	Emb.
0072.972015	PG 1012 Prato Giratório Z com bucha	5/1 pçs.

## Pés de Mesa FGVTN



+no SITE

**Material:** Aço e plástico

**Acabamento:** Cromo escovado, cromado, branco e preto fosco

Código	Descrição	Emb.
8G127FC04730104	60x730 Cromado	1 conj.
8G127FC04730204	60x730 Cor Branco	1 conj.
8G127FC04730404	60x730 Cor Preto Fosco	1 conj.
8G127FC04730504	60x730 Cromo Escovado	1 conj.

\*Conjunto com 4 peças

## Suporte Dobrável Compacto para Tampo



OU



+no SITE

**Acabamento:** Pintura epóxi pó branca

Código	Descrição	Emb.
0087.010030	300 mm Branco	20 pares
0087.010040	400 mm Branco	20 pares

## Suporte Dobrável para Tampo



+no SITE

**Acabamento:** Pintura epóxi pó branca

Código	Descrição	Emb.
0087.020030	300 mm Branco	20 pares
0087.020040	400 mm Branco	15 pares
0087.020130	300 mm Cromado	20 pares
0087.020140	400 mm Cromado	15 pares

## Cabideiro

Basculante FGVTN Dual Slow



+no SITE

**Acabamento:** Prata e cromado  
**Observação:** Amortecimento na abertura e no fechamento

Código	Descrição	Emb.
7AGSFG06000890	Cor Prata/Cromado 660-890 mm	6/1 conj.
7AGS6FG06001210	Cor Prata/Cromado 890-1210 mm	6/1 conj.

## Cabideiro

Basculante TN



+no SITE

**Acabamento:** Preto e cromado  
**Observação:** Amortecimento no fechamento

Código	Descrição	Emb.
7AG03TN18800100	Cor Preto/Cromado 660-890 mm	6/1 conj.
7AG03TN18900100	Cor Preto/Cromado 890-1210 mm	6/1 conj.

## Porta-Panos Deslizante

TTS 40 202 e TTS 40 104



+no SITE

Código	Descrição	Emb.
0079.978980	TTS 40 202 Branco	10 pçs.
0079.978981	TTS 40 202 Cinza cromo	10 pçs.
0079.978982	TTS 40 202 Alumínio fosco	10 pçs.
0079.978984	TTS 40 202 Cromado	10 pçs.
0079.978996	TTS 40 104 Cinza cromo	10 pçs.
0079.978997	TTS 40 104 Alumínio fosco	10 pçs.
0079.978998	TTS 40 104 Cromado	10 pçs.
0079.978999	TTS 40 104 Branco	10 pçs.

## Ferragem Deslizante para Teclado **TTS 082 BT**

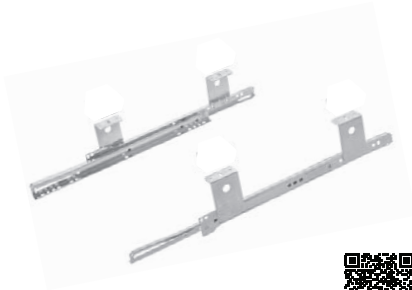

+no SITE

**Acabamento:** Pintura eletrostática epóxi branco ou preto

Código	Descrição	Emb.
0079.979085	082 BT350 Preto	10 pares
0079.979086	082 BT350 Branco	10 pares

## Ferragem Deslizante para Teclado **TTS 40 504**



+no SITE

**Acabamento:** Zinco eletrolítico cromatizado azul ou preto

Código	Descrição	Emb.
0079.979005	TTS 40/504 Zincado Preto	10 pares

## Ferragem Deslizante para Teclado **TTS 40 404**



+no SITE

**Acabamento:** Zinco eletrolítico cromatizado azul ou preto

Código	Descrição	Emb.
0079.979006	TTS 40/404 Zincado	10 pares
0079.979007	TTS 40/404 Zincado Preto	10 pares

## Ferragem Deslizante para Teclado TTS 40 204



+no SITE

**Acabamento:** Pintura eletrostática epóxi preto e zinco eletrolítico cromatizado preto

Código	Descrição	Emb.
0079.979009	TTS 40/204 Zincado Preto H122	5 pçs.

## Base para Teclado TN 27/350



+no SITE

**Material:** Aço relaminado  
**Acabamento:** Zinco eletrolítico cromatizado preto

Código	Descrição	Emb.
0079.980010	TN 27/350	25 conj.

## Rodízio FGVTN



RG 35



RG 50 com rolamento



RG 75 com rolamento

**Material:** Aço, policarbonato e poliuretano

**Acabamento:** Cromado/incolor

**Fixação:** Base com 4 parafusos

Código	Descrição	Altura	Carga	Emb.
0084.335001	RG35 incolor Cromado c/ freio	51 mm	35 kg	50 pçs.
0084.150000	RG50 c/ Rolamento Incolor Cromado s/ Freio	63 mm	40 kg	50 pçs.
0084.150001	RG50 c/ Rolamento Incolor Cromado c/ Freio	63 mm	40 kg	50 pçs.
0084.157500	RG75 c/ Rolamento Incolor Cromado s/ Freio	91 mm	55 kg	50 pçs.
0084.157501	RG75 c/ Rolamento Incolor Cromado c/ Freio	91 mm	55 kg	50 pçs.



+no SITE



LANÇAMENTO

## Rodízio neo FGVTN



100 mm



+no SITE



75 mm



**Material:** Base zincada, corpo com pintura metálica cinza, rodízio em composição de plástico na cor cinza e verde - capa central preta

**Fixação:** Base com 4 parafusos

Código	Descrição	Altura	Carga	Emb.
0084.207500	Rodízio Neo FGVTN 75 mm s/ freio	108 mm	50 kg	50 pçs.
0084.207501	Rodízio Neo FGVTN 75 mm c/ freio	108 mm	50 kg	50 pçs.
0084.210000	Rodízio Neo FGVTN 100 mm s/ freio	133 mm	85 kg	40 pçs.
0084.210001	Rodízio Neo FGVTN 100 mm c/ freio	133 mm	85 kg	40 pçs.

## Rodízio Gel TN



RG 35



RG 50



RG 75



RG 100

Material: Aço e poliuretano



+no SITE



Código	Descrição	Altura	Carga	Emb.
0084.035000	RG35 Incolor sem Freio	50 mm	35 kg	50 unid.
0084.035001	RG35 Incolor com Freio	50 mm	35 kg	50 unid.
0084.035200	RG35 Fumê sem Freio	50 mm	35 kg	50 unid.
0084.035201	RG35 Fumê com Freio	50 mm	35 kg	50 unid.
0084.050000	RG50 Incolor sem Freio	64 mm	40 kg	50 unid.
0084.050001	RG50 Incolor com Freio	64 mm	40 kg	50 unid.
0084.050200	RG50 Fumê sem Freio	64 mm	40 kg	50 unid.
0084.050201	RG50 Fumê com Freio	64 mm	40 kg	50 unid.
0084.075000	RG75 Incolor sem Freio	97 mm	55 kg	20 unid.
0084.075001	RG75 Incolor com Freio	97 mm	55 kg	20 unid.
0084.075200	RG75 Fumê sem Freio	97 mm	55 kg	20 unid.
0084.075201	RG75 Fumê com Freio	97 mm	55 kg	20 unid.
0084.100000	RG100 Incolor sem Freio	125 mm	65 kg	12 unid.
0084.100001	RG100 Incolor com Freio	125 mm	65 kg	12 unid.
0084.100200	RG100 Fumê sem Freio	125 mm	65 kg	12 unid.
0084.100201	RG100 Fumê com Freio	125 mm	65 kg	12 unid.

## Rodízio Gel **TN**

Base Fixa



RG 35



RG 50



RG 75

Material: Aço e poliuretano (incoler)



+no SITE

Código	Descrição	Altura	Carga	Emb.
0084.035010	RG35 Incoler	50 mm	35 kg	100 pçs.
0084.050010	RG50 Incoler	65 mm	40 kg	50 pçs.
0084.075010	RG75 Incoler	98 mm	55 kg	20 pçs.

LANÇAMENTO

## Porta-Pratos

FGVTN



+no SITE



Código	Descrição	Emb.
0075.PP1400	Porta-pratos FGVTN	20/1 peças

LANÇAMENTO

## Porta-Facas Inox

FGVTN



+no SITE

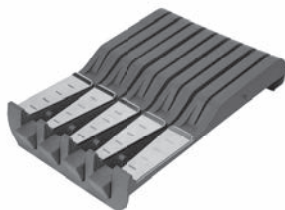

Código	Descrição	Emb.
566FGSSBP0120	Porta-Facas Inox FGVTN	20/1 peças

+ no SITE: Catálogos, manuais de instalação e desenhos técnicos



## Sistema Deslizante SDS 800 Slow

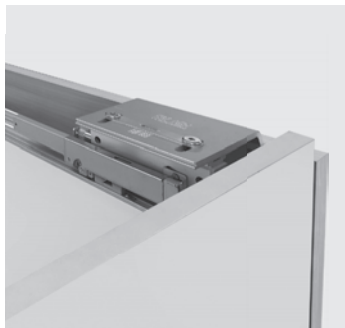

+no SITE



+no SITE

**Observação:** Completo para instalação, com kit de montagem e manual de instruções

Código	Descrição	Emb.
0086.800SX130	SDS 800 Slow p/ 1 porta (0-30kg)	4 kits
0086.800SX180	SDS 800 Slow p/ 1 porta (30-80kg)	4 kits
0086.800SXT	Kit Trilho 4m p/ SDS 800 Slow	4 conj.

Código	Descrição	Emb.
0086.800SX230	SDS 800 Slow p/ 2 portas (0-30kg)	4 kits
0086.800SX280	SDS 800 Slow p/ 2 portas (30-80kg)	4 kits
0086.800SXT	Kit Trilho 4m p/ SDS 800 Slow	4 conj.

Código	Descrição	Emb.
0086.800SX330C	SDS 800 Slow p/ 3 portas + Amortecedor Central (0-30kg)	4 kits
0086.800SX380C	SDS 800 Slow p/ 3 portas + Amortecedor Central (30-80kg)	4 kits
0086.800SX330CI	SDS 800 Slow p/ 3 portas + CI (0-30kg)	4 kits
0086.800SX380CI	SDS 800 Slow p/ 3 portas + CI (30-80kg)	4 kits
0086.800SXT	Kit Trilho 4m p/ SDS 800 Slow	4 conj.

## Amortecedor para Porta Central



Amortecedor vendido separadamente

Código	Descrição	Emb.
0086.800SXC	Amortecedor Central 30-80kg	6/1 conj.
0086.800SXC30	Amortecedor Central 0-30kg	6/1 conj.
0086.800SXC25	Amortecedor Lateral 25kg	10/1 conj.

## Sistema Deslizante Coplanar



+no SITE

**Material:** Peças em alumínio, rolamentos blindados e trilhos em alumínio

**Acabamento:** Pintura epóxi pó e zinco eletrolítico

**Fixação:** Parafusos cabeça chata PHS 4x16 mm e 4x20 mm

**Observação:** Completo para instalação, com kit de montagem e manual de instruções

Código	Descrição	Emb.
0086.CO2060	Sist. Coplanar FGVTVN 2.000mm	1 kit
0086.CO2560	Sist. Coplanar FGVTVN 2.500mm	1 kit

## Rodízio SD 802

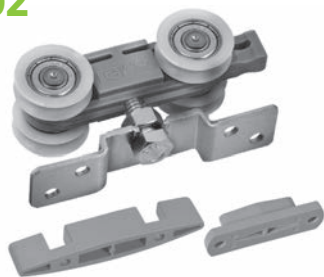

+no SITE

Código	Emb.
0086.080002	30/1 conj.

## Rodízio SD 801

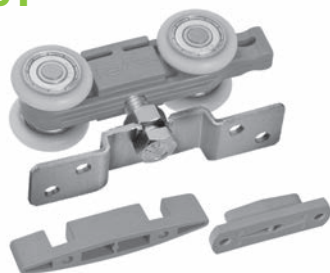

+no SITE

Código	Emb.
0086.080001	30/1 conj.

Rodízio  
**SD 632**

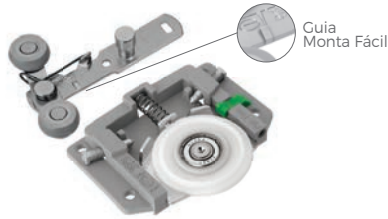

+no SITE

Código	Emb.
0086.060032	50/1 conj.

Rodízio  
**SD 631**

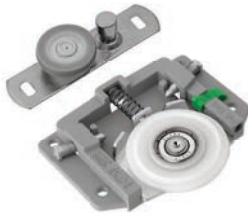

+no SITE

Código	Emb.
0086.060031	50/1 conj.

Rodízio  
**SD 605**

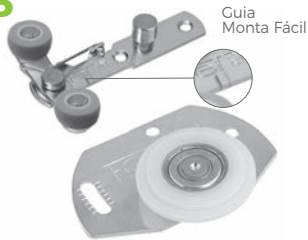

+no SITE

Código	Emb.
0086.060005	50/1 conj.

\*Kit acompanha parafusos

Rodízio  
**SD 603**



+no SITE

Código	Emb.
0086.060003	75/1 conj.

\*Kit acompanha parafusos

Rodízio  
**SD 524**

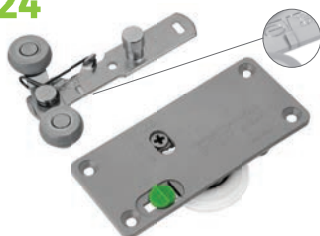

Guia  
Monta Fácil



+no SITE

Código	Emb.
0086.050024	50/1 conj.

Rodízio  
**SD 523**



+no SITE

Código	Emb.
0086.050023	50/1 conj.

Rodízio  
**SD 505**



OU



+no SITE

Código	Emb.
0086.050005	100/1 conj.

\*Kit acompanha parafusos

Rodízio  
**SD 401**



+no SITE

Código	Emb.
0086.040001	75/1 conj.

\*Kit acompanha parafusos

Rodízio  
**SD 309**

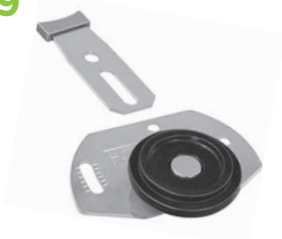

+no SITE

Código	Emb.
0086.030009	125/1 conj.

\*Kit acompanha parafusos

Rodízio  
**SD 308**



+no SITE

Código	Emb.
0086.030008	125/1 conj.

\*Kit acompanha parafusos

Rodízio  
**SD 307**



+no SITE

Código	Emb.
0086.030007	100/1 conj.

\*Kit acompanha parafusos

Rodízio  
**SD 306**



+no SITE

Código	Emb.
0086.030006	100/1 conj.

\*Kit acompanha parafusos

## Rodízio SD 305



+no SITE

Código	Emb.
0086.030005	75/1 conj.

\*Kit acompanha parafusos

## Rodízio SD 304



+no SITE

Código	Emb.
0086.030004	100/1 conj.

\*Kit acompanha parafusos

## Rodízio SD 303



+no SITE

Código	Emb.
0086.030003	100/1 conj.

\*Kit acompanha parafusos

## Rodízio SD 302



+no SITE

Código	Emb.
0086.030002	125/1 conj.

\*Kit acompanha parafusos



Rodízio  
**SD 301**



+no SITE

Código	Emb.
0086.030001	125/1 conj.

\*Kit acompanha parafusos

Rodízio  
**SD 152**



+no SITE

Código	Emb.
0086.015002	125/1 conj.

\*Kit acompanha parafusos

**LANÇAMENTO**

Rodízio  
**SD 102**



+no SITE

Código	Emb.
0086.010002	150 kits

\*Kit acompanha parafusos

Rodízio  
**SD 101**



+no SITE

Código	Emb.
0086.010001	125/1 conj.

\*Kit acompanha parafusos

## Desempenador de Portas

Embutido FGVTN



+no SITE

**Material:** Componentes em aço e plástico. Perfil de alumínio.

Código	Emb.
0086.300210	10 conj.

## Desempenador de Portas

Sobreposto FGVTN



+no SITE

**Material:** Componentes em aço e plástico. Perfil de alumínio.

Código	Emb.
0086.300110	10 conj.

Deslizador de Piso

## DP 01



+no SITE



Código	Emb.
0086.080101	100 conj.

\*Kit acompanha parafusos  
\*\*Para uso com SD801/802

## Batente de Borracha

para Portas

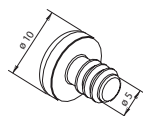

+no SITE



Código	Emb.
0086.015101	25/1 kits

## Guia Superior

Articulado para SD

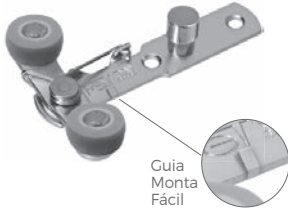

Guia  
Monta  
Fácil



+no SITE

Código	Descrição	Emb.
0086.060108	Kit Guia Sup. Art. p/SD 1 Porta	75/1 kits

## SoftDoor - Dispositivo Slowmotion

para Portas de Correr

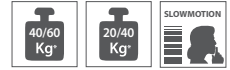

OU

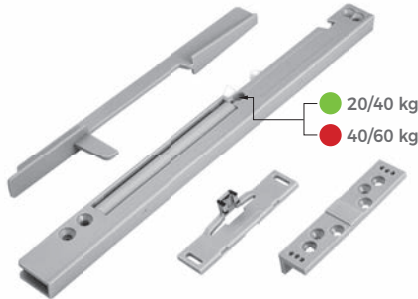

● 20/40 kg  
● 40/60 kg



+no SITE

**Material:** Componentes plásticos  
**Fixação:** Parafuso cabeça lenticilha PHS autoperfurante 4x15 mm, parafuso cabeça lenticilha PHS 4x8 mm e 4x15 mm, parafuso cabeça chata PHS autoperfurante 4x13 mm

Código	Descrição	Emb.
0086.SX2040	Para 20/40 kg	20/1 conj.
0086.SX4060	Para 40/60 kg	20/1 conj.

SAIBA +

SISTEMAS  
DESLIZANTES

### CÁLCULO PARA RODÍZIOS DESLIZANTES

A especificação correta do número de dobradiças e a escolha correta do sistema ou rodízio deslizante garante o melhor funcionamento e durabilidade para o seu projeto.

Acesse nosso site e insira nos campos, os valores das medidas de largura, altura e espessura em milímetros e tenha a indicação do produto mais adequado.



+ no SITE: Catálogos, manuais de instalação e desenhos técnicos



SHOWROOM  
VIRTUAL



LANÇAMENTO

## Articulador FGVTN Multi



Aplicação	Carga
1 Kit (direito ou esquerdo)	3 - 4 kg
1 par (direito + esquerdo)	5 - 7 kg



+no SITE

Código	Descrição	Emb.
591LMDIR3040W30	Direito	30/1 kits
591LMESQ3040W30	Esquerdo	30/1 kits

## Articulador FLAP

FCVTN 902



+no SITE

**Material:** Aço relaminado  
**Acabamento:** Niquelado

Código	Emb.
515902TN06050	50/1 pares

## Braço de Abertura

Variável BVO



+no SITE

**Material:** Zamak  
**Acabamento:** Niquelado

Código	Emb.
595BV0050000N	25/1 peças

## Pistão a Gás com Amortecedor FGVTN



+no SITE



Código (Cinza)	Código (Branco)	N	Emb.
595KFG0604X050	595KFG0704X050	40N	50/1 pcs.
595KFG0606X050	595KFG0706X050	60N	50/1 pcs.
595KFG0608X050	595KFG0708X050	80N	50/1 pcs.
595KFG0610X050	595KFG0710X050	100N	50/1 pcs.
595KFG0612X050	595KFG0712X050	120N	50/1 pcs.

## Pistão a Gás TN



- 1- Conector para porta de madeira
- 2- Conector para lateral de armário



+no SITE

**Material:** Aço e plástico  
**Acabamento:** Corpo do pistão na cor branca ou cinza, haste cromada e conectores niquelados

Código (Cinza)	Código (Branco)	N	Emb.
595KTN436040000	595KTN437040000	40N	50/1 pçs.
595KTN436060000	595KTN437060000	60N	50/1 pçs.
595KTN436080000	595KTN437080000	80N	50/1 pçs.
595KTN436100000	595KTN437100000	100N	50/1 pçs.
595KTN436120000	595KTN437120000	120N	50/1 pçs.
595KTN436140000	595KTN437140000	140N	50/1 pçs.

**SAIBA +**

**PISTÕES A GÁS**

### INSTALAÇÃO CORRETA PARA TODOS OS MODELOS DE PISTÕES

Sempre instalar com o corpo para cima e haste para baixo.



## Pistão a Gás

TN FI

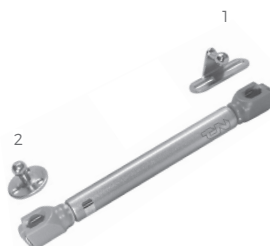

- 1- Conector para porta de madeira
- 2- Conector para lateral de armário



+no SITE

**Material:** Aço e plástico

**Acabamento:** Corpo do pistão na cor branca ou cinza, haste cromada e conectores niquelados

Código (Cinza)	Código (Branco)	N	Emb.
595LTN436060000	595LTN437060000	60N	50/1 pçs.
595LTN436080000	595LTN437080000	80N	50/1 pçs.
595LTN436100000	595LTN437100000	100N	50/1 pçs.
595LTN436120000	595LTN437120000	120N	50/1 pçs.
595LTN436140000	595LTN437140000	140N	50/1 pçs.

## Pistão a Gás

TN Mini FI

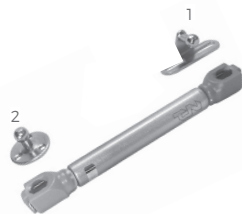

- 1- Conector para porta de madeira
- 2- Conector para lateral de armário



+no SITE

**Material:** Aço e plástico

**Acabamento:** Corpo do pistão na cor branca ou cinza, haste cromada e conectores niquelados

Código (Cinza)	Código (Branco)	N	Emb.
595MLTN436040000	595MLTN437040000	40N	100/1 pçs.
595MLTN436060000	595MLTN437060000	60N	100/1 pçs.
595MLTN436080000	595MLTN437080000	80N	100/1 pçs.

## Pistão a Gás

TN Mini



- 1- Conector para porta de madeira
- 2- Conector para lateral de armário



+no SITE

**Material:** Aço e plástico

**Acabamento:** Corpo do pistão na cor branca ou cinza, haste cromada e conectores niquelados

Código (Cinza)	Código (Branco)	N	Emb.
595MTN436040000	595MTN437040000	40N	100/1 pçs.
595MTN436060000	595MTN437060000	60N	100/1 pçs.
595MTN436080000	595MTN437080000	80N	100/1 pçs.

LANÇAMENTO

## Pulsador Magnético

Embutido FGVTN Mini



+no SITE

**Material:** Corpo plásticas e chapa metálica para fixação na porta

**Acabamento:** Cinza

Código	Descrição	Emb.
590400FG27P6M00	Embutido FGVTN Mini	500/100 pçs.

## Pulsador Magnético FGVTN

Embutido e Sobreposto



Sobrepor



Embutir



**Material:** Corpo e base plásticas e chapa metálica para fixação na porta

**Acabamento:** Branco ou cinza

Código	Descrição	Emb.
590400FG27S1100	Sobreposto FGVTN Branco	500/100 pçs.
590400FG27S6100	Sobreposto FGVTN Cinza	500/100 pçs.
590400FG27P1100	Embutido FGVTN Branco	500/100 pçs.
590400FG27P6100	Embutido FGVTN Cinza	500/100 pçs.



+no SITE

## Pulsador Magnético TN

Magnético TN



+no SITE

**Acabamento:** Branco ou cinza

Código	Descrição	Emb.
590400TNP1100	Branco	500/100 pçs.
590400TNP6100	Cinza	500/100 pçs.

## Pulsador

Magnético **TN** Industrial



+no SITE

Acabamento: Branco ou cinza

Código	Descrição	Emb.
590400TN46P <b>1100</b>	Branco	500/100 pçs.
590400TN46P <b>6100</b>	Cinza	500/100 pçs.



## Fecho Toque

Articulado **TN**



+no SITE

Material: Corpo metálico, base plástica com lingueta Zamak e mola metálica  
Acabamento: Niquelado

Código	Descrição	Emb.
7DS03TN23010 <b>100</b>	Cinza	500/100 conj.



## Amortecedor **TN**

com Suporte Cruz



+no SITE

Código	Descrição	Emb.
595300TNP <b>6100</b>	Cinza	500/100 conj.



## Amortecedor **TN**

com Suporte Linear



+no SITE

Código	Descrição	Emb.
595400TNP <b>6100</b>	Cinza	500/100 conj.
595400TNP <b>1100</b>	Branco	500/100 conj.







## AEROMax Slow



+no SITE

Abertura: Total

Código	Descrição	Emb.
591FLD051200G08	AEROMax Slow	8/1 conj.
<b>Acessório (vendido separadamente)</b>		
591FLTCAPAW	Capa Branca	20/1 conj.

\*Kit completo - acompanha capa cor cinza

## AEROMax Touch



HA

HB



+no SITE

Pulsador Magnético  
(Versão One-Touch)



Abertura: Total

Código	Descrição	Emb.
592FLT030600G08	3 a 6kg (HA)	8/1 conj.
592FLT061100G08	6 a 11kg (HB)	8/1 conj.
<b>Acessório (vendido separadamente)</b>		
591FLTCAPAW	Capa Branca	20/1 conj.

\*Kit completo - acompanha capa cor cinza

## AEROFlex



**Abertura:** Dobrável e Superior

Código	Descrição	Emb.
591BFA050700G04	FA (4 a 7 kg)	4/1 conj.
591BFB070900G04	FB (7 a 9 kg)	4/1 conj.
591BFC091100G04	FC (9 a 11 kg)	4/1 conj.
591BFD111300G04	FD (11 a 13 kg)	4/1 conj.

### Acessórios (vendidos separadamente)

591BFA0507DOG04	Kit Dob. (Sup+Cen)	50/1 conj.
591BFDCAPAW	Capa Branca	20/1 conj.



+no SITE

\*Kit completo - acompanha capa cor cinza

## AEROVert PLUS

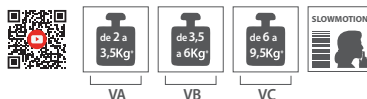

+no SITE

**Abertura:** Linear e Superior

Código	Descrição	Emb.
592VEA020300GKT	Kit AeroVert Plus VA	4/1 conj.
592VEB030600GKT	Kit AeroVert Plus VB	4/1 conj.
592VEC060900GKT	Kit AeroVert Plus VC	4/1 conj.

### Acessório (vendido separadamente)

592VECAPAW	Capa Branca	20/1 conj.
------------	-------------	------------

\*Kit completo - acompanha capa cor cinza

## SAIBA +

### SISTEMAS DE ABERTURA E AEROS FGVTN

#### SISTEMA DE ABERTURA COM FECHAMENTO SUAVE

Pistão a Gás com Amortecedor FGVTN



Amortecimento na abertura e fechamento da porta.

## AEROSmart



Smart 3

Smart 5

Smart 8



+no SITE

**Abertura:** Total (solução compacta)

Código	Descrição	Emb.
591FLA020300G080	2 a 3kg (Smart 3)	8/1 conj.
591FLB030500G080	3 a 5kg (Smart 5)	8/1 conj.
591FLC050800G080	5 a 8kg (Smart 8)	8/1 conj.
Acessório (vendido separadamente)		
591FLCCAPAW	Capa Branca	20/1 conj.

\*Kit completo - acompanha capa cor cinza

## AEROPlus



Montagem combinada  
com dobradiças  
com amortecimento  
(slowmotion)



+no SITE

**Abertura:** Total

Código	Descrição	Emb.
590VXFGVTN25015	AEROPlus	15/1 conj.

## AEROSFGVTN

**MODELOS:**

- AeroMax Slow
- AeroMax Touch
- AeroFlex
- AeroVert Plus
- AeroSmart
- AeroPlus



CINZA

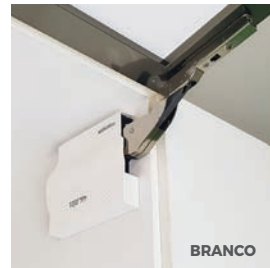

BRANCO

+no SITE: Catálogos, manuais de instalação e desenhos técnicos



SHOWROOM  
VIRTUAL



## Kit Gaveta Metálica AvantBOX® Slowmotion



+no SITE

Acabamento: Prata, inox e branco

Código	Descrição	Emb.
0076.00A6450000	450 mm Prata	1 kit
0076.00A6500000	500 mm Prata	1 kit
0076.00F0450000	450 mm Inox	1 kit
0076.00F0500000	500 mm Inox	1 kit
0076.00W0450000	450 mm Branco	1 kit
0076.00W0500000	500 mm Branco	1 kit

## Kit Gaveta Metálica AvantBOX® One-Touch



+no SITE

Acabamento: Prata, inox e branco

Código	Descrição	Emb.
0076.00A6450OT0	450 mm Prata OT	1 kit
0076.00A6500OT0	500 mm Prata OT	1 kit
0076.00F0450OT0	450 mm Inox OT	1 kit
0076.00F0500OT0	500 mm Inox OT	1 kit
0076.00W0450OT0	450 mm Branco OT	1 kit
0076.00W0500OT0	500 mm Branco OT	1 kit

Kit Gaveta Metálica  
*AvantBOX*® Tubo  
Lateral e Transversal

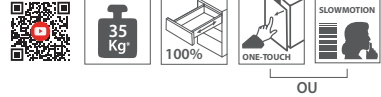

Acabamento: Prata, inox e branco

	Código	Descrição	Emb.
PRATA	0076.04A6RB1100	2 Tubos Transv. 1100 + 8 conec. 'T'	1 kit
	0076.01A6450164	Tubo Lateral H164 450 mm	25 conj.
	0076.01A6450204	Tubo Lateral H204 450 mm	25 conj.
	0076.01A6500164	Tubo Lateral H164 500 mm	25 conj.
	0076.01A6500204	Tubo Lateral H204 500 mm	25 conj.

	Código	Descrição	Emb.
INOX	0076.04FORB1100	2 Tubos Transv. Ni 1100 + 8 conec. 'T'	1 kit
	0076.01F0450164	Tubo Lateral H164 450 mm	25 conj.
	0076.01F0450204	Tubo Lateral H204 450 mm	25 conj.
	0076.01F0500164	Tubo Lateral H164 500 mm	25 conj.
	0076.01F0500204	Tubo Lateral H204 500 mm	25 conj.

	Código	Descrição	Emb.
BRANCO	0076.04WORB1100	2 Tubos Transv. Branco	1 kit
	0076.01W0450164	Tubo Lateral H164 450 mm	25 conj.
	0076.01W0450204	Tubo Lateral H204 450 mm	25 conj.
	0076.01W0500164	Tubo Lateral H164 500 mm	25 conj.
	0076.01W0500204	Tubo Lateral H204 500 mm	25 conj.



+no SITE

Kit Gaveta Metálica  
*AvantBOX*® Elevação  
Lateral em Acrílico

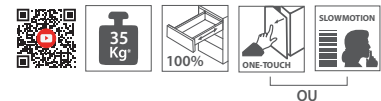

Acabamento: Prata, inox e branco

	Código	Descrição	Emb.
	0076.02A6450ACR	450 mm Prata	1 kit
	0076.02A6500ACR	500 mm Prata	1 kit
	0076.02F0450ACR	450 mm Inox	1 kit
	0076.02F0500ACR	500 mm Inox	1 kit
	0076.02W0450ACR	450 mm Branco	1 kit
	0076.02W0500ACR	500 mm Branco	1 kit



+no SITE

## GAVETAS METÁLICAS

### Kit Gaveta Metálica *AvantBOX*® Elevação Lateral Metálica

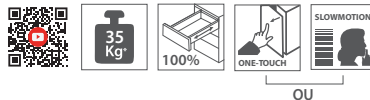

+no SITE

**Acabamento:** Prata, inox e branco

Código	Descrição	Emb.
0076.02A6450MET	450 mm Prata	1 kit
0076.02A6500MET	500 mm Prata	1 kit
0076.02F0450MET	450 mm Inox	1 kit
0076.02F0500MET	500 mm Inox	1 kit
0076.02W0450MET	450 mm Branco	1 kit
0076.02W0500MET	500 mm Branco	1 kit

### Divisor Central para Gavetas *AvantBOX*®



+no SITE

**Acabamento:** Alumínio fosco ou branco

Código	Descrição	Emb.
0076.06A6450	415 mm Al. Fosco	1 pç.
0076.06A6500	465 mm Al. Fosco	1 pç.
0076.06W0450	415 mm Branco	1 pç.
0076.06W0500	465 mm Branco	1 pç.

### Tapete Emborrachado para Gavetas

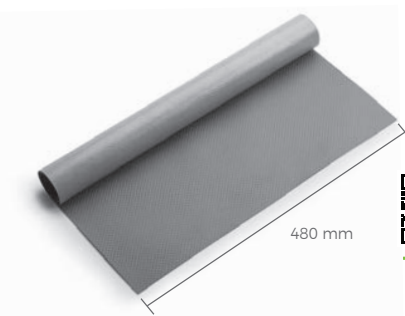

+no SITE

**Acabamento:** Cinza

Código	Descrição	Emb.
58PT5006RC00520	Cinza 20 m	1 peça
58PT5006RC00502	Cinza 2 m	25 peças



## Divisores Internos para Gavetas *AvantBOX*<sup>®</sup>



**Acabamento:** Prata, inox e branco

Código	Descrição	Emb.
0076.05W0C00H00	Conector Branco p/ divisor horizontal	20/1 kit
0076.05C00H00C	Conector Cinza p/ divisor horizontal	20/1 kit

	Código	Descrição	Emb.
PRATA	0076.05A6600H00	Horizontal 600 mm	10/1 kit
	0076.05A6900H00	Horizontal 900 mm	10/1 kit
	0076.05A61200H0	Horizontal 1200 mm	10/1 kit
	0076.05A6110V00	Vertical	20/1 kit

	Código	Descrição	Emb.
INOX	0076.05F0600H00	Horizontal 600 mm	10/1 kit
	0076.05F0900H00	Horizontal 900 mm	10/1 kit
	0076.05F01200H0	Horizontal 1200 mm	10/1 kit
	0076.05F0110V00	Vertical	20/1 kit

	Código	Descrição	Emb.
BRANCO	0076.05W0600H00	Horizontal 600 mm	10/1 kit
	0076.05W0900H00	Horizontal 900 mm	10/1 kit
	0076.05W01200H0	Horizontal 1200 mm	10/1 kit
	0076.05W0110V00	Vertical	20/1 kit



+no SITE

## Kit Gaveta Metálica *AvantBOX*<sup>®</sup> Slim Baixa H89

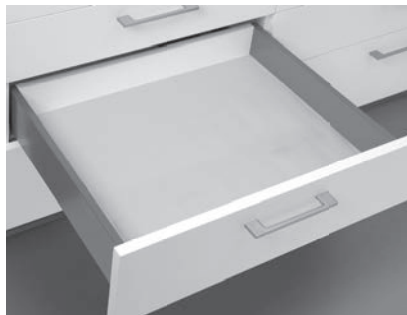

**Acabamento:** Cinza

Código	Descrição	Emb.
0076.10DG450089	Gaveta Avantbox <sup>®</sup> Slim Cinza 450 mm H89	1 kit
0076.10DG500089	Gaveta Avantbox <sup>®</sup> Slim Cinza 500 mm H89	1 kit



+no SITE

## Acessório para Gaveta Metálica *AvantBOX® Slim* Baixa H89

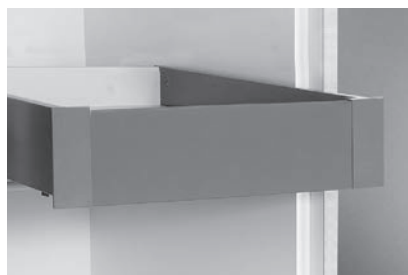

+no SITE

Acabamento: Cinza

Código	Descrição	Emb.
0076.12DC08089	Kit Frontal para Gaveta Interna H89	1 Conj.

## Kit Gaveta Metálica *AvantBOX® Slim* Média H121

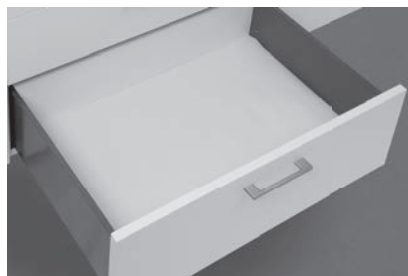

+no SITE

Acabamento: Cinza

Código	Descrição	Emb.
0076.10DG450121	Gaveta Avantbox® Slim Cinza 450 mm H121	1 kit
0076.10DG500121	Gaveta Avantbox® Slim Cinza 500 mm H121	1 kit

## Acessório para Gaveta Metálica *AvantBOX® Slim* Média H121

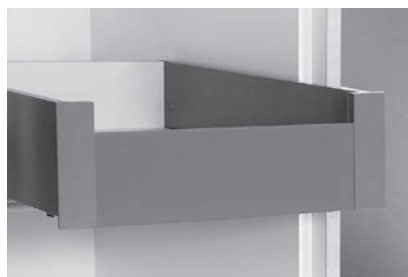

+no SITE

Acabamento: Cinza

Código	Descrição	Emb.
0076.12DC08121	Kit Frontal para Gaveta Interna H121	1 Conj.



## Kit Gaveta Metálica *AvantBOX® Slim* Alta H185

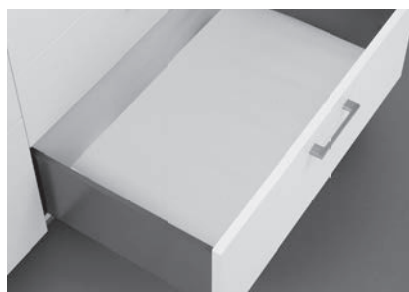

+no SITE

**Acabamento:** Cinza

Código	Descrição	Emb.
0076.10DC450185	Gaveta Avantbox® Slim Cinza 450 mm H185	1 kit
0076.10DC500185	Gaveta Avantbox® Slim Cinza 500 mm H185	1 kit

## Acessório para Gaveta Metálica *AvantBOX® Slim* Alta H185



+no SITE

**Kit Frontal para Gaveta Interna**

Código	Descrição	Emb.
0076.12DG08185	Kit Frontal para Gaveta Interna H185	1 Conj.

**Acabamento:** Cinza

## Acessório para Elevação Lateral e Transversal

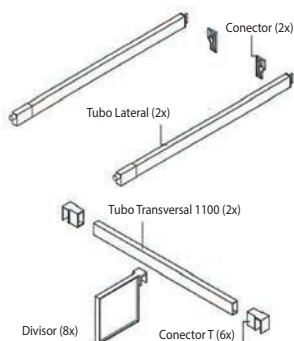

**Kit Elevação Lateral**

Código	Referência	Quantidade
0076.11DG450000	450 mm	1
0076.11DG500000	500 mm	1

**Kit Tubo Transversal com Divisor**

Código	Referência	Quantidade
0076.12DGT1100	450 e 500 mm	1

## Porta-Talheres Tetrax

Universal em Plástico



+no SITE

**Material:** Polipropileno

**Acabamento:** Branco ou champagne

Código	Descrição	Emb.
59T001F1280U000	Branco 300/350 mm	25 pçs.
59T001S6280U000	Champanhe 300/350 mm	25 pçs.
59T001F1400U000	Branco 400/450 mm	25 pçs.
59T001S6400U000	Champanhe 400/450 mm	25 pçs.
59T001F1500U000	Branco 500/550 mm	25 pçs.
59T001S6500U000	Champanhe 500/550 mm	25 pçs.
59T001F1550U000	Branco 600 mm	25 pçs.
59T001S6550U000	Champanhe 600 mm	25 pçs.

## Perfil de União



+no SITE

**Observação:** Utilizar somente com porta-talheres Tetrax

Código	Descrição	Emb.
595GNZS64460000	450 mm	150 pçs.
595GNZS65000000	500 mm	150 pçs.

SAIBA+

SISTEMA DE GAVETAS METÁLICAS  
AvantBOX®

### 4 CONFIGURAÇÕES DISPONÍVEIS

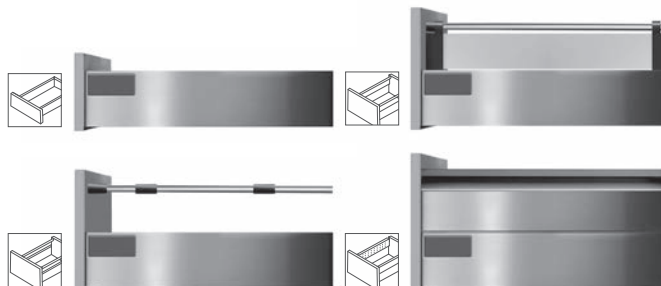



## Divisores Internos

em Aço Inox



+no SITE



**Material:** Aço inox 304

Código	Descrição	Emb.
566TNB450010	103 x 450 mm	10/1 conj.
566TNB500010	103 x 500 mm	10/1 conj.



Código	Descrição	Emb.
566TNC450005	280 x 450 mm	5/1 conj.
566TNC500005	280 x 500 mm	5/1 conj.



Código	Descrição	Emb.
566TND450005	376 x 450 mm	5/1 conj.
566TND500005	376 x 500 mm	5/1 conj.



Código	Descrição	Emb.
566TNE450005	516 x 450 mm	5/1 conj.
566TNE500005	516 x 500 mm	5/1 conj.



Código	Descrição	Emb.
566TNF450020	290 x 450 mm	20/1 conj.
566TNF500020	290 x 500 mm	20/1 conj.

## Divisor de Talheres FGVTN



+no SITE



**Acabamento:** Cinza ou branco

Código	Descrição	Emb.
0075.C830480	Cinza 830x480	10/1 un.
0075.B830480	Branco 830x480	10/1 un.
0075.C830430	Cinza 830x430	10/1 un.
0075.B830430	Branco 830x430	10/1 un.

Código	Descrição	Emb.
0075.C735480	Cinza 735x480	10/1 un.
0075.B735480	Branco 735x480	10/1 un.
0075.C735430	Cinza 735x430	10/1 un.
0075.B735430	Branco 735x430	10/1 un.

Código	Descrição	Emb.
0075.C635480	Cinza 635x480	10/1 un.
0075.B635480	Branco 635x480	10/1 un.
0075.C635430	Cinza 635x430	10/1 un.
0075.B635430	Branco 635x430	10/1 un.

Código	Descrição	Emb.
0075.C540480	Cinza 540x480	10/1 un.
0075.B540480	Branco 540x480	10/1 un.
0075.C540430	Cinza 540x430	10/1 un.
0075.B540430	Branco 540x430	10/1 un.

Código	Descrição	Emb.
0075.C435480	Cinza 435x480	10/1 un.
0075.B435480	Branco 435x480	10/1 un.
0075.C435430	Cinza 435x430	10/1 un.
0075.B435430	Branco 435x430	10/1 un.

Código	Descrição	Emb.
0075.C390480	Cinza 390x480	10/1 un.
0075.B390480	Branco 390x480	10/1 un.
0075.C390430	Cinza 390x430	10/1 un.
0075.B390430	Branco 390x430	10/1 un.

Código	Descrição	Emb.
0075.C315480	Cinza 315x480	10/1 un.
0075.B315480	Branco 315x480	10/1 un.
0075.C315430	Cinza 315x430	10/1 un.
0075.B315430	Branco 315x430	10/1 un.



## Quadro para Pasta Suspensa QPS 800

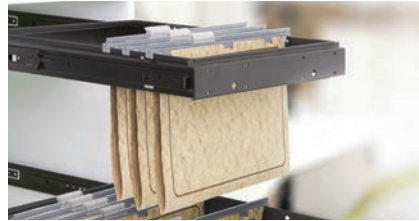
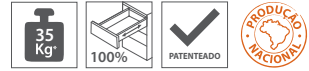

+no SITE

Código	Descrição	Emb.
0081.757100	Kit 1 35 kg 422x414 mm	1 conj.
0081.757101	Kit 2 35 kg 422x514 mm	1 conj.
0081.757102	Kit 3 35 kg 710x414 mm	1 conj.
0081.757103	Kit 4 35 kg 838x414 mm	1 conj.

## Quadro para Pasta Suspensa QPS 1000

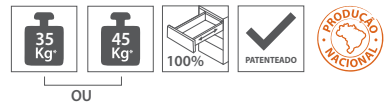

+no SITE

Código	Descrição	Emb.
0081.757120	Kit 5 35 kg 422x414 mm	1 conj.
0081.757121	Kit 6 35 kg 422x514 mm	1 conj.
0081.757122	Kit 7 35 kg 710x414 mm	1 conj.
0081.757123	Kit 8 35 kg 838x414 mm	1 conj.
0081.757130*	Kit 9 45 kg 422x414 mm	1 conj.
0081.757131*	Kit 10 45 kg 422x514 mm	1 conj.
0081.757132*	Kit 11 45 kg 710x414 mm	1 conj.
0081.757133*	Kit 12 45 kg 838x414 mm	1 conj.

\*Self-Closing

## FECHADURAS PARA MÓVEIS

+ no SITE: Catálogos, manuais de instalação e desenhos técnicos



## Fechadura para Gaveta

20x17 mm



+no SITE

ou



+no SITE

**Tipo de chave:** Fixa ou escamoteável com acabamento plástico polido**Acabamento:** Niquelado

Código	Descrição	Emb.
0089.861221	Chave fixa	200/20 pçs.
0089.861221 IN	Industrial	400 pçs.
0089.861221 KA	Fechadura KA (chave fixa)	200/20 pçs.
0089.861222 SB	Chave escamoteável	200/20 pçs.

KA: Mesmos segredos

## Fechadura para Gaveta

31x17 mm



+no SITE

ou



+no SITE

**Tipo de chave:** Fixa ou escamoteável com acabamento plástico polido**Acabamento:** Niquelado

Código	Descrição	Emb.
0089.861311	Chave fixa	200/20 pçs.
0089.861311 IN	Industrial	400 pçs.
0089.861311 KA	Fechadura KA (chave fixa)	200/20 pçs.
0089.861312 SB	Chave escamoteável	200/20 pçs.

KA: Mesmos segredos

## Fechadura para Armário

Vertical



+no SITE

ou



+no SITE

**Tipo de chave:** Fixa com acabamento plástico polido**Acabamento:** Niquelado

Código	Descrição	Emb.
0089.871221	20 mm	200/20 pçs.
0089.871221 KA	Fechadura KA 20 mm	200/20 pçs.
0089.871231	31 mm	200/20 pçs.
0089.871231 KA	Fechadura KA 31 mm	200/20 pçs.

KA: Mesmos segredos

## Fechadura de Sobrepor

para Gaveta 19x21 mm



+no SITE

**Tipo de chave:** Escamoteável com acabamento plástico polido  
**Acabamento:** Niquelado

Código	Descrição	Emb.
0089.860222	19x21 mm	200/20 pçs.

## Fechadura para Gaveteiro

Frontal



+no SITE

**Tipo de chave:** Escamoteável com acabamento plástico polido  
**Acabamento:** Niquelado

Código	Emb.
0089.288002	200/20 pçs.

## Fechadura para Gaveteiro

Frontal 1 Aba



+no SITE

**Tipo de chave:** Escamoteável com acabamento plástico polido  
**Acabamento:** Niquelado

Código	Emb.
0089.328002	200/20 pçs.

## Fechadura

para Porta de Vidro



+no SITE

**Tipo de chave:** Fixa com acabamento plástico polido  
**Acabamento:** Niquelado

Código	Emb.
0089.408001	200/20 pçs.

## Fechadura para

Portas de Vidro Duplo



+no SITE

**Tipo de chave:** Fixa com acabamento plástico polido  
**Acabamento:** Niquelado

Código	Emb.
0089.409001	200/20 pçs.

## Fechadura para

Vitrine 140 mm



+no SITE

**Tipo de chave:** Fixa com acabamento plástico polido  
**Acabamento:** Niquelado

Código	Emb.
0089.970001	240/12 pçs.

## Fechadura para

Porta de Correr

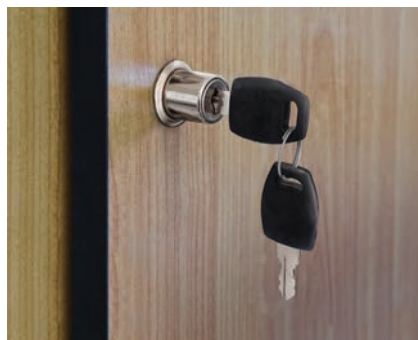

+no SITE

**Tipo de chave:** Fixa com acabamento plástico polido  
**Acabamento:** Niquelado

Código	Emb.
0089.202001	200/20 pçs.



## Fechadura para Móveis

de Madeira 19x20 mm



+no SITE

**Tipo de chave:** Escamoteável com acabamento plástico polido

**Acabamento:** Niquelado

Código	Emb.
0089.441002	200/20 pçs.

## Fechadura para Móveis

em Aço com Lingueta



+no SITE

**Tipo de chave:** Escamoteável com acabamento plástico polido

**Acabamento:** Niquelado

Código	Emb.
0089.430001	200/20 pçs.

## Fechadura Cilindro de Pressão

22x36 mm



+no SITE

**Tipo de chave:** Escamoteável com acabamento plástico polido

**Acabamento:** Niquelado

Código	Emb.
0089.871432	200/20 pçs.

## Fechadura para Gaveta

20x17 mm Lingueta Longa



+no SITE

**Tipo de chave:** Fixa com acabamento plástico polido

**Acabamento:** Niquelado

Código	Emb.
0089.861221LL	200/20 pçs.

## Fechadura Cilindro de Pressão

para Porta de Correr 8x11 mm



+no SITE

**Tipo de chave:** Escamoteável com acabamento plástico polido

**Acabamento:** Niquelado

Código	Emb.
0089.421002	250/25 pçs.

## Batente Metálico

para Fechaduras



+no SITE

**Material:** Aço niquelado

Código	Emb.
0089.999003	200/20 pçs.

## Batente Plástico

10x30 mm



+no SITE

**Material:** Polipropileno (acabamento cinza)

Código	Emb.
0089.999001	200/20 pçs.



## Calço Plástico

Ø17x47 mm



+no SITE

**Material:** Polipropileno (acabamento cinza)

Código	Emb.
0089.999002	200/20 pçs.



## Pino Batente para Barras de Travamento



**Material:** Zamak  
**Acabamento:** Biocromatizado



+no SITE

Código	Descrição	Emb.
0089.008009	9 m	100 pçs./caixa
0089.008013	13 mm	100 pçs./caixa
0089.008017	17 mm	100 pçs./caixa

## Fechadura para Gaveteiro Frontal com Acessórios e Barra



**Tipo de chave:** Escamoteável com acabamento plástico polido  
**Acabamento:** Niquelado



+no SITE

Código	Descrição	Emb.
0089.288102	Fechadura com acessórios + barra 1.000 mm para 5 gaveteiros	50/1 pçs.
0089.288502	Fechadura com acessórios + barra 500 mm para 4 gaveteiros	50/1 pçs.

**SAIBA +**

**FECHADURAS  
PARA MÓVEIS**

**DOIS MODELOS DE  
CHAVES DISPONÍVEIS  
DE ACORDO COM O  
TIPO DE FECHADURA**



Chave fixa



Chave escamoteável

## Fechadura para Gaveteiro Lateral

com Acessórios e Barra



+no SITE

**Tipo de chave:** Escamoteável com acabamento plástico polido

**Acabamento:** Niquelado

Código	Descrição	Emb.
0089.108102	Sistema com acessórios + barra 1.000 mm para 5 gaveteiros	50/1 pçs.
0089.108502	Sistema com acessórios + barra 500 mm para 4 gaveteiros	50/1 pçs.

## Fechadura Cremona

com Lingueta e Acessórios



+no SITE

**Tipo de chave:** Escamoteável com acabamento plástico polido

**Acabamento:** Niquelado

Código	Descrição	Emb.
0089.730002	Fechadura cremona com Lingueta e acessórios	100/10 pçs.
0089.7300500	Barra 500 mm fechadura cremona	100/20 pçs.
0089.7301000	Barra 1000 mm fechadura cremona	100/20 pçs.
0089.7301500	Barra 1500 mm fechadura cremona	100/20 pçs.



SHOWROOM  
VIRTUAL

## Dispositivo FBA45 Zamak

Niquelado 16/19 mm



+no SITE

Código	Emb.
0091.002011	500/100 pçs.

## Dispositivo FBA45

Plástico 16/19 mm



+no SITE

Código	Descrição	Emb.
0091.002014	Marrom	1.000/100 pçs.
0091.002012	Branco	1.000/100 pçs.

## Dispositivo FB Zamak

Niquelado 16/19 mm



+no SITE

Código	Emb.
0091.002001	500/100 pçs.

## Dispositivo FB

Plástico 16/19 mm



+no SITE

Código	Descrição	Emb.
0091.002002	Branco	1.000/100 pçs.
0091.002003	Preto	1.000/100 pçs.
0091.002004	Marrom	1.000/100 pçs.

## Dispositivo FAA45 Zamak

Niquelado 16/19 mm



+no SITE

Código	Emb.
0091.002111	1.000/100 pçs.

## Dispositivo FAA45

Plástico 16/19 mm



+no SITE

Código	Descrição	Emb.
0091.002114	Marrom	2.500/100 pçs.
0091.002112	Branco	2.500/100 pçs.

## Dispositivo FA Zamak

Niquelado 16/19 mm



+no SITE

Código	Emb.
0091.002101	1.000/100 pçs.

## Dispositivo FA

Plástico 16/19 mm



+no SITE

Código	Emb.
0091.002102	2.500/100 pçs.

## Parafuso FA/FB

Aço Zincado 1/4"x11 mm



+no SITE

Código	Emb.
0091.208001C	5.000/100 pçs.
0091.208001IN	6.000 pçs.

## Parafuso FA/FB

Aço Zincado M6x8 mm



+no SITE

Código	Emb.
0091.208002C	5.000/100 pçs.
0091.208002IN	5.000 pçs.

## Parafuso Aço FA/FB

com Ponta 1/4"x21,5 mm



+no SITE

Código	Emb.
0091.208006	5.000/100 pçs.

## Parafuso FA/FB

Aço Zincado 1/4"x7,5 mm



+no SITE

Código	Emb.
0091.208005	5.000/100 pçs.

## Haste Dupla FA/FB

Aço Zincado 19 mm



Para espessura de 19 mm



+no SITE

Código	Emb.
0091.208003	2.500/100 pçs.

## Haste Dupla FA/FB

Aço Zincado 16 mm



Para espessura de 16 mm



+no SITE

Código	Emb.
0091.208004	2.500/100 pçs.

## Tambor Zamak

Zincado 15x12 mm



Para MDF de 15 mm



+no SITE

Código	Emb.
0091.001513	4.000/500 pçs.
0091.001513C	3.000/100 pçs.
<b>KIT</b> 0090.001513	100 kits

## Tambor Zamak

Zincado 15x13,5 mm



Para MDF de 18 mm



+no SITE

Código	Emb.
0091.001514	4.000/500 pçs.
0091.001514C	3.000/100 pçs.
<b>KIT</b> 0090.001514	100 kits

## Parafuso Aço

Zincado 6x32 mm



+no SITE

Código	Emb.
0091.232002C	100 pçs.
0091.232002IN	3.000 pçs.

## Parafuso Aço

Zincado M6x32 mm



+no SITE

Código	Emb.
0091.232001IN	3.500 pçs.
0091.232001C	100 pçs.

## Haste Dupla/Trava

Aço Zincado 67 mm

Para espessura  
de 18 mm



+no SITE

Código	Emb.
0091.262003	1.000/100 pçs.

## Haste Dupla/Trava

Aço Zincado 64 mm

Para espessura  
de 15 mm



+no SITE

Código	Emb.
0091.262001	1.000/100 pçs.

## Bucha Americana Zamak

Bicromatizado M6x13 mm



+no SITE

Código	Emb.
0091.401008	2.500/100 peças
KIT 0091.401008IN	10.000 peças

## Bucha Plástica

Ø1,4"10x11 mm



+no SITE

Cor: Preto

Código	Emb.
0091.401005	10.000/100 pçs.



## Bucha Plástica

M6 10x11 mm



+no SITE

Código	Emb.
0091.401 <b>002</b>	10.000/100 pçs.

## Bucha Plástica Branca

ø10x10 mm



+no SITE

Código	Emb.
2H011TN01 <b>1010</b>	1.000 pçs.

## Suporte Prateleira

Pino Duplo Zamak Niquelado



+no SITE

Código	Emb.
0091.801 <b>015</b>	2.000 peças
0091.801 <b>015C</b>	100 peças

## Suporte Prateleira

Fixa Plástico

Suporte já vem com o parafuso



+no SITE

Código	Descrição	Emb.
0091.002 <b>201</b>	Branco	2.500/100 pçs.
0091.002 <b>203</b>	Marrom	2.500/100 pçs.
<b>KIT</b> 0090.002 <b>201</b>	Branco (kit)	100/1 kit

## Suporte Prateleira

Aço Niquelado 7,5x12,5 mm



+no SITE

Código	Emb.
0091.801 <b>014</b>	2.000/100 pçs.
<b>KIT</b> 0090.801 <b>014</b>	100/1 kit

## Suporte Prateleira Trapézio

Plástico Incolor e Aço Niquelado



+no SITE

Código	Emb.
0091.801 <b>002</b>	5.000/100 pçs.
<b>KIT</b> 0090.801 <b>002</b>	100/1 kit

## Suporte Prateleira Vidro

Zamak Niquelado 6 a 10 mm



+no SITE

Código	Emb.
0091.801 <b>013</b>	1.000/100 pçs.

## Suporte Prateleira Duplo

ø5x16 mm



+no SITE

Código	Emb.
0091.801 <b>001C</b>	5.000/100 pçs.
<b>KIT</b> 0090.801 <b>001</b>	200/1 kit

## Suporte Prateleira

90 Zamak Niquelado 5 mm



+no SITE

Código	Emb.
0091.801 <b>004</b>	3.000/100 pçs.
<b>KIT</b> 0090.801 <b>004</b>	100/1 kit

## Suporte Prateleira Vidro

Zamak Niquelado 3 a 6 mm



+no SITE

Código	Emb.
0091.801 <b>003</b>	1.000/100 pçs.

## Suporte Prateleira Vidro

Paralelo Zamak Niquelado



+no SITE

Código	Emb.
0091.801 <b>005</b>	2.500/100 pçs.

## Suporte Prateleira Vidro

90 Zamak Niquelado



+no SITE

Código	Emb.
0091.801 <b>006</b>	5.000/100 pçs.
<b>KIT</b> 0090.801 <b>006</b>	100/1 kit

## Suporte Prateleira

Niquelado 17x17 mm 2 Furos



+no SITE

Código	Emb.
0091.801011	1.000/100 pçs.
<b>KIT</b> 0090.801011	100/1 kit

## Suporte Plástico

10x15 mm



+no SITE

Código	Descrição	Emb.
0091.810001	Branco	20.000/1.000 pçs.
0091.810001C	Branco	15.000/100 pçs.
0091.810002	Marrom	20.000/1.000 pçs.
0091.810003	Preto	20.000/1.000 pçs.
0091.810004	Cinza	20.000/1.000 pçs.
0091.810005	Marfim	20.000/1.000 pçs.
<b>KIT</b> 0090.810001	Branco	100/1 kit
<b>KIT</b> 0090.810002	Marrom	100/1 kit
<b>KIT</b> 0090.810003	Preto	100/1 kit

## Arremate Plástico

10x9 mm



+no SITE

Código	Descrição	Emb.
0091.809001	Branco	20.000/1.000 pçs.
0091.809002	Marrom	20.000/1.000 pçs.
0091.809003	Preto	20.000/1.000 pçs.
0091.809004	Cinza	20.000/1.000 pçs.
0091.809005	Marfim	20.000/1.000 pçs.

## Suporte Prateleira

2 Furos Zamak Niquelado ou Branco



+no SITE

Código	Descrição	Emb.
0091.801008	Niquelado	10.000/1.000 pçs.
0091.801008C	Niquelado	5.000/100 pçs.
0091.801010	Branco	2.000/100 pçs.
<b>KIT</b> 0090.801008	Niquelado	200/1 kit

## Trapézio Plástico

ø5x10 mm



+no SITE

Código	Descrição	Emb.
0091.805001	Branco	20.000/1.000 pçs.
0091.805002	Marrom	20.000/1.000 pçs.
0091.805003	Preto	20.000/1.000 pçs.
0091.805004	Cinza	20.000/1.000 pçs.
0091.805005	Marfim	20.000/1.000 pçs.

## Suporte Plástico

ø8xø6 mm



+no SITE

Código	Descrição	Emb.
0091.808001	Branco	20.000/1.000 pçs.
0091.808002	Marrom	20.000/1.000 pçs.
0091.808003	Preto	20.000/1.000 pçs.
0091.808004	Cinza	20.000/1.000 pçs.
0091.808005	Marfim	20.000/1.000 pçs.
<b>KIT 0090.808001</b>	Branco	100/1 kit

## Parafuso União

Plástico 30-40



+no SITE

Código	Descrição	Emb.
0091.501004	Marrom	2.000/100 pçs.
0091.501002	Branco	2.000/100 pçs.

## Trava Prateleira

Plástico 18 mm



+no SITE

Código	Emb.
0091.811102	5.000/100 pçs.

## Trava Prateleira

Plástico 16 mm



+no SITE

Código	Emb.
0091.811002	5.000/100 pçs.

## Parafuso União

Niquelado 30-40



+no SITE

Código	Emb.
0091.501001	1.000/500 pçs.

## Parafuso Euro Aço

Niquelado 6,3x15 mm



+no SITE

Código	Emb.
1A07511505000	1.000 pçs.

## Parafuso Aço

Niquelado 4x15,5 mm



+no SITE

Código	Emb.
1A03503425000	40.000/1.000 pçs.

## Parafuso Aço

Niquelado sem Ponta para Bucha



Utiliza bucha  
10 x 10 mm



+no SITE

Código	Emb.
1A045034350TR	1.000 pçs.

## Porca Cilíndrica Zamak

Natural 1/4"



+no SITE

Código	Descrição	Emb.
0091.401101	1/4" x 10 mm	1.000 pçs.
0091.401101C	1/4" x 10 mm	100 pçs.
0091.401102	1/4" x 12 mm	1.000 pçs.
0091.401102C	1/4" x 12 mm	5.000/100 pçs.
KIT 0090.401102	1/4" x 12 mm	100/1 kit

## Tapa Furo Plástico

ø5 mm



+no SITE

Código	Descrição	Emb.
0091.705001	Branco	50.000/2.000 pçs.
0091.705002	Marrom	50.000/2.000 pçs.
0091.705003	Preto	50.000/2.000 pçs.
0091.705004	Cinza	50.000/2.000 pçs.
0091.705005	Marfim	50.000/2.000 pçs.
KIT 0090.705001	Branco	100/1 kit

## Tapa Furo Plástico

ø8 mm



+no SITE

Código	Descrição	Emb.
0091.708001	Branco	50.000/2.000 pçs.
0091.708002	Marrom	50.000/2.000 pçs.
0091.708003	Preto	50.000/2.000 pçs.
0091.708004	Cinza	50.000/2.000 pçs.
0091.708005	Marfim	50.000/2.000 pçs.
KIT 0090.708001	Branco	100/1 kit

## Tapa Furo Plástico

ø10 mm



+no SITE

Código	Descrição	Emb.
0091.710001	Branco	50.000/2.000 pçs.
0091.710002	Marrom	50.000/2.000 pçs.
0091.710003	Preto	50.000/2.000 pçs.
0091.710004	Cinza	50.000/2.000 pçs.
0091.710005	Marfim	50.000/2.000 pçs.
KIT 0090.710001	Branco	100/1 kit

## Tapa Furo Plástico

Ø12 mm



+no SITE

Código	Descrição	Emb.
0091.712001	Branco	50.000/2.000 pçs.
0091.712002	Marrom	50.000/2.000 pçs.
0091.712003	Preto	50.000/2.000 pçs.
0091.712004	Cinza	50.000/2.000 pçs.
0091.712005	Marfim	50.000/2.000 pçs.
<b>KIT</b> 0090.712001	Branco	100/1 kit

## Porca Garra

M8x10 mm



Pode usar com o Pé Nivelador



+no SITE

Código	Emb.
0091.901033	3.500 pçs.
0091.901033C	3.500/100 pçs.

## Porca Garra

M6x10 mm



Pode usar com o Pé Nivelador



+no SITE

Código	Emb.
0091.901022	6.000 pçs.
0091.901022C	5.000/100 pçs.

## Suspensor FGVTN

HB65



+no SITE



Código	Embalagem
0091.510012	50 kits

## Suspensor de Armário



+no SITE



Código	Embalagem
0091.510010	25 kits

A LINHA **FIX SYSTEM** DA FGVTN TEM DIVERSAS OPÇÕES DE **PÉS NIVELADORES** PARA A MONTAGEM DE SEUS MÓVEIS.

## Pé Nivelador



75 mm

55 mm



+no SITE



	Código	Descrição	Emb.
	0086.015102	75 mm (4 pçs.)	35/1 conj.
	0086.015103	55 mm (4 pçs.)	35/1 conj.
KIT	0090.015102	75 mm (4 pçs.)	50/1 kit
KIT	0090.015103	55 mm (4 pçs.)	50/1 kit

LANÇAMENTO

## Pé Nivelador

D27,5 M6x25



+no SITE

Código	Embalagem
0091.901027	100 conj.
0091.901027IN(**)	2.000 conj.
0091.401009IN	20.000 conj.
0091.901022	6.000 conj.

(\*\*) Não acompanha bucha plástica.

LANÇAMENTO

## Pé Nivelador

Inox D38 M8x15



+no SITE



Código	Emb.
0091.901038	50/1 kits
0091.901038IN	500 peças
0091.401010IN(**)	10.000 peças

(\*\*) Não acompanha bucha plástica.

## Pé Nivelador



ø21

ø32



+no SITE



+no SITE

	Código	Descrição	Emb.
	0091.901021	ø21 mm	1.000/100 pçs.
	0091.901032	ø32 mm	500/50 pçs.
KIT	0090.901021	ø21 mm	100/1 kit
KIT	0090.901032	ø32 mm	100/1 kit

UMA EMPRESA DO GRUPO



# VENHA COM A MELHOR!



**FGVTN Brasil Ltda**  
Curitiba/PR



**Centro de Distribuição FGVTN**  
Itajaí/SC



**Formenti & Giovenzana S.p.A.**  
Veduggio - Itália

Produtos sujeitos a alterações sem aviso prévio - 06/2022 - Catálogo: 0099.000011



[fgvtn.com.br](http://fgvtn.com.br)