

Kit Gaveta Metálica AvantBox® Slowmotion

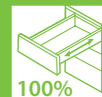

Passo a passo

Video disponível
no YouTube

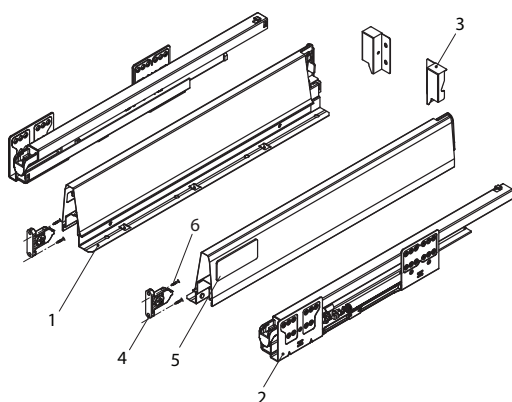

Componentes:

- 1 - Laterais de gaveta (par)
 - 2 - Corrediça (par)
 - 3 - Suporte para traseiro de madeira H86 (par)
 - 4 - Conector frontal (2x)
 - 5 - Tampa lateral (2x)
 - 6 - Parafuso 4x20 mm (4x) para fixação do conector frontal.
- Observação: Acompanha manual de instalação.

Acabamento: Prata, inox e branco

Código	Descrição	Embalagem
0076.00A6450000	Kit Gaveta AvantBox 450 mm Prata	1 kit
0076.00A6500000	Kit Gaveta AvantBox 500 mm Prata	1 kit
0076.00F0450000	Kit Gaveta AvantBox 450 mm Inox	1 kit
0076.00F0500000	Kit Gaveta AvantBox 500 mm Inox	1 kit
0076.00W0450000	Kit Gaveta AvantBox 450 mm Branco	1 kit
0076.00W0500000	Kit Gaveta AvantBox 500 mm Branco	1 kit

Dimensões corte da Gaveta

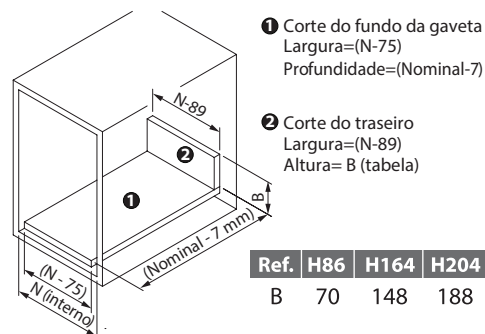

Fixação Corrediça

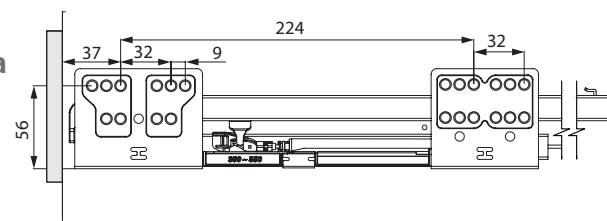

Dimensões para Instalação (H86) - Kit Gaveta Básica

Posição corrediça no móvel

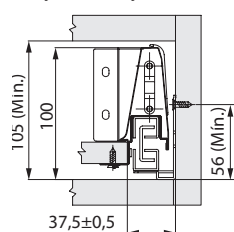

Posição conector frontal

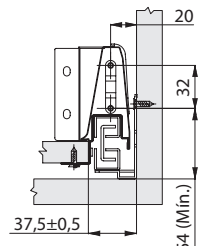

Furação conector no frontal da gaveta

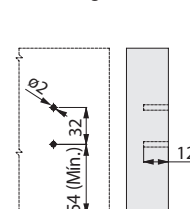

Posição Suporte para Traseiro de Madeira

